TECHNICAL MANUAL

OPERATOR'S,
ORGANIZATIONAL, DIRECT SUPPORT,
AND GENERAL SUPPORT
MAINTENANCE MANUAL

TROPOSPHERIC SCATTER TACTICAL
RADIO RELAY SYSTEM

This copy is a reprint which includes current
pages from Change 1.

H E A D Q U A R T E R S , D E P A R T M E N T O F T H E A R M Y

OCTOBER 1975

CHANGE }
No. 1 }

HEADQUARTERS
DEPARTMENT OF THE ARMY
WASHINGTON, DC, 14 October 1977

**OPERATOR'S, ORGANIZATIONAL, DIRECT SUPPORT,
AND GENERAL SUPPORT MAINTENANCE MANUAL
TROPOSPHERIC SCATTER TACTICAL RADIO RELAY SYSTEM**

TM 11-5895-459-14, 23 October 1975, is changed as follows:

1. A vertical bar appears opposite changed material.
2. Remove and insert pages as outlined in the page list below.

<i>Remove</i>	<i>Insert</i>
1-11	1-1/(1-2 blank)
6-7 and 6-8.....	and 6-7 and 6-8

File this change sheet in front of manual for reference purposes.

By Order of the Secretary of the Army:

BERNARD W. ROGERS
General, United States Army
Chief of Staff

Official:

J. C. PENNINGTON
Brigadier General, United States Army
The Adjutant General

Distribution:

Active Army:

USASA
COE (1)
TSG (1)
USAARENBD (1)
DARCOM (1)
TRADOC (2)
OS Maj Comd (4)
TECOM (2)
USACC (4)
MDW (1)
Armies (2)
Corps (2)
Svc Colleges (1)
USASIGS (5)
MAAG (1)
USARMIS(1)
USAERDAA(1)
USAERDAW (1)
USAADS(2)
USAFAS (2)
USAARMS (1)
USAIS (2)
USAES (2)
USAICS (3)
Ft Monmouth (HISA) (33)

Fort Gillem (10)
Fort Gordon (10)
Fort Huachuca (10)
Fort Carson (5)
Ft Richardson (ECOM) (2)
Army Dep (1) except
LBAD (14)
SAAD (30)
TOAD (14)
SHAD 0)
USA Dep (2)
Sig See USA Dep (2)
Sig Dep (2)
Sig FLDMS (D)
Units org under fol TOE (1 cy each)
11-35
11-205
11-215
11-237
29-15
29-55
29-85
29-134
44-235
44-535

NG: None

USAR: None

For explanation of abbreviations, used see AR 310-50.



**Operator's, Organizational, Direct Support, and General Support
Maintenance Manual**

TROPOSPHERIC SCATTER TACTICAL RADIO RELAY SYSTEM

	Paragraph	Page
CHAPTER 1. INTRODUCTION		
Scope.....	1-1	1-1
Indexes of publications	1-2	1-1
Forms and records.....	1-3	1-1
Reporting of errors.....	1-4	1-1
Administrative storage	1-5	1-1
Destruction of Army materiel	1-6	1-1
CHAPTER 2. BASIC PULSE-CODE MODULATION PRINCIPLE		
Section I Introduction		
General	2-1	2-1
Principles of multiplexing.....	2-2	2-1
II. Principles of Pulse-Code Modulation		
General	2-3	2-1
Voice transmission-by pulse-code modulation.....	2-4	2-2
Type of pulse-code modulation used	2-5	2-2
CHAPTER 3. COMPONENT DESCRIPTION AND DATA		
Multiplexer TD-204/U	3-1	3-1
Multiplexer TD-754/G	3-2	3-1
Restorer, Pulse Form TD-206/G	3-3	3-2
MultiplexerTD-352/U	3-4	3-2
Converter, Telephone Signal CV-1548/G	3-5	3-4
Converter, Telegraph-Telephone Signal CV-425/U	3-6	3-5
Radio Set AN/GRC-143	3-7	3-6
Radio Set-AN/GRC-106A	3-8	3-10
Power Supply PP-4763A/G RC.....	3-9	3-10
Regulator, Voltage CN-514/GRC	3-10	3-13
Antenna Group AN/TRA-37	3-11	3-13
TA-312/PT and LS-147C/FI	3-12	3-14
Transmission cable and Test Set, Telephone AN/PTM-7	3-13	3-14
4. ASSEMBLAGE DESCRIPTION AND DATA		
General characteristics	4-1	4-1
Terminal Sets, Telephone AN/TCC-60 and AN/TCC-69.....	4-2	4-1
Terminal Set, Telephone AN /TCC-61	4-3	4-1
Radio Terminal Set AN/TRC-112.....	4-4	4-2
Radio Terminal Set AN/TRC-121.....	4-5	4-2
5. ASSEMBLAGE CAPABILITIES		
General	5-1	5-1
Terminal Sets, Telephone AN/TCC-60 and AN/TCC-69.....	5-2	5-1
Terminal Set, Telephone AN/TCC-61	5-3	5-1
Radio Terminal Set AN/TRC-112.....	5-4	5-1
Radio Terminal Set AN/TRC-121.....	5-5	5-1
Section 6. SYSTEM DESCRIPTION AND ENGINEERING		
I. Description and Data		
Purpose and use.....	6-1	6-1
System assemblages	6-2	6-1
Capabilities and limitations	6-3	6-1
II. Systems Engineering		
General	6-4	6-1
Requirements for communications planning and antenna siting procedures	6-5	6-1
Site considerations	6-6	6-1
Performance prediction	6-7	6-5
Propagation losses	6-8	6-5
Tropospheric scatter systems engineering	6-9	6-6
System installation, assembly and line-up.....	6-10	6-9
Antenna assembly and orientation	6-11	6-9

	Paragraph	Page
CHAPTER 7. MAINTENANCE CONCEPT		
General	7-1	7-1
Organizational maintenance	7-2	7-1
Direct support maintenance	7-3	7-2
General support maintenance	7-4	7-2
Depot maintenance.....	7-5	7-2
APPENDIX		
GLOSSARY		A-1
		Glossary 1

LIST OF ILLUSTRATIONS

<i>Number</i>	<i>Title</i>	<i>Page</i>
2-1	Simplified telephone system showing simple tdm.....	2-1
2-2	Simplified 12-channel tdm system	2-2
3-1	Multiplexer TD-204/U.....	3-2
3-2	Multiplexer TD-754/G.....	3-3
3-3	Restorer, Pulse Form TD-206/G.....	3-4
3-4	Multiplexer TD-352/U.....	3-5
3-5	Adapter Connector UG-1923/G.....	3-6
3-6	Converter, Telephone Signal CV-1548/G.....	3-7
3-7	Converter, Telegraph-Telephone Signal CV-425/U, front view of panel.....	3-8
3-8	Radio Set AN/GRC-143	3-11
3-9	Radio Set AN/GRG-106A.....	3-12
3-10	Power Supply PP-4763A/GRC.....	3-13
3-11	Regulator, Voltage CN-514/GRC	3-14
3-12	Antenna Group AN/TRA-37.....	3-15
3-13	Telephone Set TA-312/PT and Intercommunication Station LS-147C/FI	3-16
3-14	Test Set, Telephone AN/PTM-7	3-17
4-1	Terminal Set, Telephone AN/TCC-60, exterior views	4-3
4-2	Terminal Set, Telephone AN/TCC-61, exterior views	4-4
4-3	Terminal Set, Telephone AN/TCC-69, exterior views	4-5
4-4	Radio Terminal Set AN/TRC-112, front roadside view.....	4-6
4-5	Radio Terminal Set AN/TRC-112, rear curbside view	4-7
4-6	Radio Terminal Set AN/TRC-121, front curbside view.....	4-8
4-7	Radio Terminal Set AN/TRC-121, rear curbside view.....	4-9
4-8	Terminal Set, Telephone AN/TCC-60, interior front view.....	4-10
4-9	Terminal Set, Telephone AN/TCC-60, interior roadside views.....	4-11
4-10	Terminal Set, Telephone AN/TCC-60, interior curbside views.....	4-12
4-11	Terminal Set, Telephone AN/TCC-69, interior front view.....	4-13
4-12	Terminal Set, Telephone AN/TCC-69, interior front roadside view	4-14
4-13	Terminal Set, Telephone AN/TCC-69, interior rear roadside view	4-15
4-14	Terminal Set, Telephone AN/TCC-69, interior front curbside view.....	4-16
4-15	Terminal Set, Telephone AN/TCC-69, interior rear curbside view	4-17
4-16	Terminal Set, Telephone AN/TCC-61, interior front view, lessTSEC/KG-27's.....	4-18
4-17	Terminal Set, Telephone AN/TCC-61, interior roadside views, less TSEC/KG-27's	4-19
4-18	Terminal Set, Telephone AN/TCC-61, interior curbside views, lessTSEC/KG-27.....	4-20
4-19	Radio Terminal Set AN/TRC-112, interior front view	4-21
4-20	Upper interior roadside front view, AN/TRC-112.....	4-22
4-21	Radio Terminal Set AN/TRC-112, interior front curbside view	4-23
4-22	Interior curbside front wall, AN/TRC-112.....	4-24
4-23	Radio Terminal Set AN/TRC-112, interior upper rear curbside view	4-25
4-24	Radio Terminal Set AN/TRC-112, interior lower rear curbside view.....	4-26
4-25	Radio Terminal Set AN/TRC-121, interior front view, packaged for shipment.....	4-27
4-26	Radio Terminal Set AN/TRC-121, interior front roadside view.....	4-28
4-27	Radio Terminal Set AN/TRC-121, interior rear roadside view.....	4-29
4-28	Radio Terminal Set AN/TRC-121, front curbside view.....	4-30
4-29	Radio Terminal Set AN/TRC-121, interior rear curbside view.....	4-31
5-1	Typical two station, tropospheric scatter, communications link	5-2
5-2	Component arrangements for 12-and24-channelcableterminalfacilities, block diagram	5-3
6-1	Typical employment of tropospheric scatter tactical radio relay system in tactical field army	6-2
6-2	Typical applications of tropospheric scatter tactical radio relay system.....	6-3
6-3	Propagation of tropospheric scatter radio signals	6-5
6-4	Effect of obstacles on horizon angle	6-5
6-6	Negative horizon angles.....	6-6
6-6	Aperture-to-medium coupling loss.....	6-6

Number	Title	Page
6-7①	Horizon angle determination curves (part 1 of 2).....	6-7
6-7②	Horizon angle determination curves (part 2 of 2).....	6-8
6-8	Antenna gain and beam width.....	6-9
6-9	Free space attenuation at 1,000 MHz	6-9
6-10	Conversion table for free space attenuation at frequencies between 4.4 and 5.0 GHz	6-10
6-11	Horizon angle loss	6-10
6-12	Calculation of aperture-to-medium coupling loss.....	6-11
6-13	Circuit reliability	6-12
7-1	Voice transmission by pulse code modulation	7-3
FO-1	Pcm-tdm principle in TD-352/U..... Located in back of manual.	

CHAPTER 1

INTRODUCTION

1-1. Scope

This manual describes the Tropospheric Scatter Tactical Radio Relay System and its relationship to other systems that comprise the Army Tactical Area Communications System (ATACS). Chapter 2 describes the fundamental principles of time division multiplexing (tdm) and pulse-code modulation (pcm) employed in the system. This manual also provides a brief description of each type of component used in the system, the basic technical characteristics of each component, and their interrelationship and applications for various types of site configurations. A description of each assemblage that is an integral part of the Tropospheric Scatter Tactical Radio Relay System is provided. The individual capabilities of each assemblage are provided as well as their application and employment principles as interrelated to the system. Chapter 7 describes the maintenance concept employed in the system.

1-2. Indexes of Publications

a. Refer to the latest issue of DA Pam 310-4 to determine whether there are new editions, changes, or additional publications pertaining to the Tropospheric Scatter Tactical Radio Relay System.

b. Refer to the latest issue of DA Pam 310-7 to determine whether there are modification work orders (MWO's) pertaining to the system.

1-3. Forms and Records

a. *Reports of Maintenance and Unsatisfactory Equipment.* Maintenance forms, records, and reports which are to be used by maintenance personnel at all maintenance levels are listed in and prescribed by TM 38-750.

b. *Report of Packaging and Handling Deficiencies.* Fill out and forward DD Form 6 (Packaging Improvement Report as prescribed in AR 700-58/NAVSUPINST 4030.29/AFR 71-13/ MCO P4030.29A, and DSAR 4145.8.

c. *Discrepancy in Shipment Report (DISREP) (SF 361).* Fill out and forward Discrepancy in Shipment Report (DISREP) (SF 361) as pre-scribed in AR 55-38/NAVSUPINST 4610.33A/AFRt 75-18/MCO P4610.19B, and DSAR 4500 15.

1-4. Reporting of Errors

Report of errors, omissions, and recommendations for improving this publication is authorized and encouraged. Reports should be submitted on DA Form 2028 (Recommended Changes to Publications and Blank Forms) direct to Commander, US Army Electronics Command, ATTN: DRSEL-MA-Q, Fort Monmouth, NJ 07703.

1-5. Administrative Storage

For procedures, forms and records, and inspections required during administrative storage of this equipment, refer to TM 740-90-1.

1-6. Destruction of Army Material

Demolition and destruction of electronic equipment will be under the direction of the commander and in accordance with TM 750-244-2.

CHAPTER 2

BASIC PULSE-CODE MODULATION PRINCIPLE

SECTION 1. INTRODUCTION

2-1. General

a. The TD-204/U or TD-754/G, TD-206/G, and TD-352/U are pulse-code modulation components used as part of multichannel communication systems. These systems use radio or cable, or combinations of both as transmission mediums. The pcm components provide 12 or 24 audio channels in a single transmission channel.

b. In a 12-channel system, separate telephone signals are converted to time-division-multiplex, pulse-code-modulation (tdm-pcm) pulse trains. These pulse trains are reshaped and retimed at repeater points in the system, and reconverted to telephone signals at a distant terminal. In a 24-channel system, the 24 telephone channels are converted into two tdm-pcm pulse trains. For radio transmission or cable transmission, the two pulse trains are interleaved and transmitted over a single radio channel or single cable.

c. The 24-channel system provides capability for intermediate terminals along the transmission path. One pulse train is repeated from the local terminal to the distant terminal, while the second pulse train terminates at the intermediate point, and a new pulse train is inserted in its place. The intermediate point (drop and insert repeater) can therefore communicate in both directions, and with both terminals. The drop and insert repeater points contain both repeater and terminal equipment.

2-2. Principles of Multiplexing

a. *General.* Multiplexing is a technique used to transmit simultaneously several channels of voice or data over a radio or cable link. Frequency-division-multiplexer (fdm) equipment utilizes a sub-carrier frequency for each voice or data channel. In time-division-multiplexer equipment, each voice or data channel shares the transmission time and is intermittently transmitted.

b. *Time Division Multiplexing.*

(1) In time division multiplexing, each voice channel is assigned a time interval in sequence with all other channels being multiplexed. These intervals are short and repeated at a high frequency. The samples taken from each channel are then converted to a form suitable for transmission in the selected medium. At the receiving terminal, the samples are demodulated and separated into their proper channels by a timing signal from the transmitting terminal.

(2) The simplified telephone circuit in figure 2-1 illustrates the time division principle. Switches S1 and S2 are synchronized, so that both are in position A at the same time, and in position B at the same time. A telephone call made on line A is completed only when the switches are in position A. The telephone calls made on line B are completed only when the switches are in position B. When both lines are in use, the switches alternate between position A and position B. If the switching rate is low, both conversations will be garbled and unintelligible. If the rate is increased, the signals will be more intelligible. When the switching rate is higher than voice frequencies, the switching is not detectable.

(3) The circuit shown in figure 2-2 is a simplified 12-channel tdm system. The two switches are rotated in synchronism. Each channel is sampled once during each revolution. Very little distortion occurs, because the 12 conversations are intelligible when the rotation speed is rapid enough. Electronic switching is used in the pcm components described in this manual. Twelve samples are taken in each time frame.

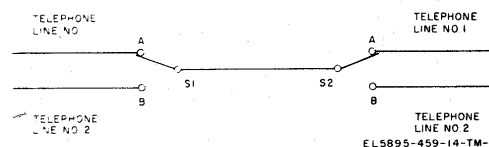

Figure 2-1. Simplified telephone system showing simple tdm.

SECTION II. PRINCIPLES OF PULSE-CODE MODULATION

2-3. General

Pulse-code modulation is a communication technique in which voice, data, or facsimile signals are converted into a series of digital pulse codes.

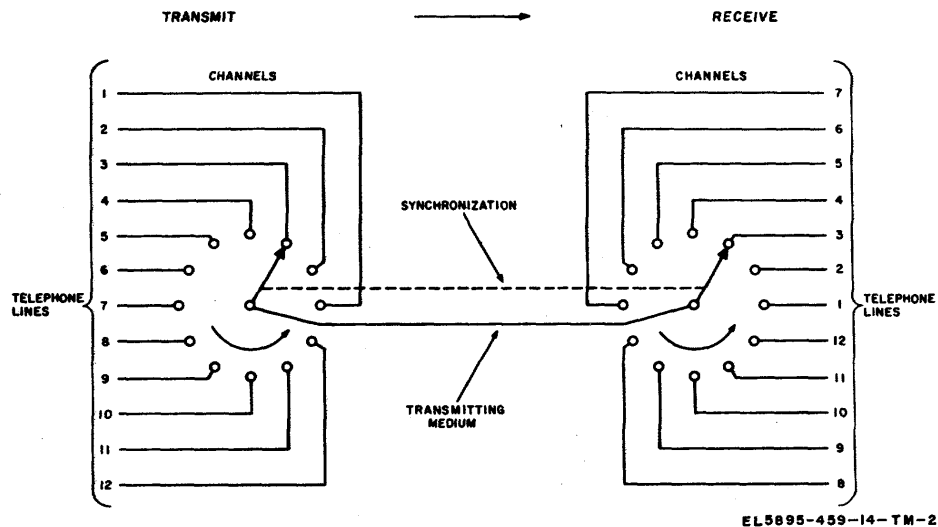

Figure 2-2. Simplified 12-channel tdm system.

Each pulse code represents signal amplitude at a particular instant. A series of pulse codes represents a complete waveform. Since the transmitted signal is in digital form, it is less susceptible to noise and distortion buildup over long distance lines, and may be regenerated at repeaters along the route without introducing additional distortion.

2-4. Voice Transmission by Pulse-Code Modulation (fig. 7-1)

In the pcm process, standard amplitude levels are assigned and represented by digital codes. The incoming voice waveform is sampled at a high rate, and each sample is converted to a pulse at the closest standard amplitude, producing a pulse-amplitude-modulated (pam) waveform. The standard amplitude pulses developed are then measured and converted to a binary pulse code for transmission. The pulse codes are decoded at the receiving station and reconverted to a pam wave-form, which is then demodulated to produce approximately the original waveform. As the sampling frequency is increased, the waveform generated at the receiver more accurately resembles the original waveform.

2-5. Type of Pulse-Code Modulation Used

a. In the TD-352/U, the amplitude range of the incoming voice signals is divided into 64 levels which are then converted to 6-digit binary pulse codes. Companding (compression-expansion) circuits are used at the voice inputs to improve the fidelity of very high-level or very low-level signals. These circuits provide nonlinear amplification which compresses high-level signals to the amplitude range required for conversion to the 64-level range of the encoder and decoder, and expands very low-level signals to provide more accurate coding. The low-level signals must be expanded because they would cover only a few pulse-code levels, and would be more distorted than the higher-level signals. A complimentary companding circuit is incorporated in the receiver circuits to restore the signals to their original levels after decoding and demodulating.

b. Each channel in the TD-352/U is pulse code-sampled once each 125 microseconds (8,000 times each second), and each pulse code occupies an interval of 10.4 microseconds. In a functional 12-channel tdm-pcm system, each modulation output is sampled in sequence to produce one pulse code in a frame consisting of twelve pulse codes. A frame sync pulse is added in place of the final digit in the last pulse code of each frame to synchronize the receiving equipment with the transmitting equipment. The frame sync pulse is identical with the other pulses in the train, and is distinguished by the received repetition pattern. FO-1 illustrates the operation of a 12-channel tdm-pcm system.

CHAPTER 3

COMPONENT DESCRIPTION AND DATA

3-1. Multiplexer TD-204/U

a. Use. Multiplexer TD-204/U (fig. 3-1) is a 12/24/48-channel pcm cable transmission inter-face unit. Its transmit section accepts tdm-pcm output signals from one or two TD-352 /U's, from another TD-204/U or TD-754/G and processes these signals for cable transmission. The receive section accepts a pcm signal from the transmission cable, processes and retimes it. In addition, the TD-204/U provides for up to 39 TD-206/G's in the transmission cable, and contains an order wire facility.

b. Technical Characteristics.

Channel capacity 12, 24, or 48
 Input voltage..... 109 to 121 volts, 47 to 63 Hz
 Power consumption 62 watts maximum Pcm input or output signal:
 Impedance 91 ohms
 Amplitude Pulses go positive to approximately 0 volts from a baseline of approximately -2 volts.
 Pulse type Binary (full width)
 Pulse rate and interval:
 12-channel operation..... 576 kHz; 1,736 µsec
 24-channel operation 1,152 kHz; 868 nsec
 48-channel operation 2,304 kHz; 434 nsec
 Timing input or output signals:
 Impedance 91 ohms
 Amplitude Positive-going pulses, 2 volts amplitude
 Pulse type Sharp spike
 Pulse width 150 nsec
 Repetition rate 576 kHz
 Repetition rate:
 12-or 24-channel operation . 576 kHz
 48-channel operation 2, 304 kHz
 Pulse width 150 nsec (max.)
 Cable input or output signals:
 Impedance 62 ohms
 Amplitude:
 To-cable signal Leading edge of pulses swing 2 volts from zero to peak.
 From cable signal 30 mV pp nominal
 Pulse type Binary dipulse
 Bit rate 2, 304 kHz
 Pulse width 180 to 230 nsec
 Compatible cable..... CX-4245/G or CX 11230/G
 Order wire:
 Facility Baseband channel independent of pcm traffic
 Frequency response 300 to 1, 700 Hz
 Signaling frequency 1, 600 Hz
 Transmit level..... 9 volts rms min. at 880 ohms (at cable transmit amplifier output
 Receive level..... Adjustable 150 mV rms to 16 volts rms across 880 ohms (at cable receive amplifier input)

3-2. Multiplexer TD-754/0

a. Use. The TD-754/G (fig. 3-2) provides the capability for transmission of pulse-code-modulation (pcm) pulses through cable transmission systems. Pcm pulses from Multiplexer TD-352/U, or similar equipment, are applied to the TD-754/G. In the TD-754/G, the pcm pulses are encoded into another pcm format and transmitted at a 2, 304-kHz rate through a cable link to another TD-754/G or TD-204/U. The TD-754/G or TD-204/U at the opposite end of the cable link decodes the pcm pulses into their original pcm format and applies them to a TD-352/U or similar equipment. The TD-754/G also provides cable current to power Restorers, Pulse Form TD-206/G installed in the cable link. Order-wire facilities that operate over the cable link are also contained in the TD-754/G to provide a phone link between terminals

b. System Information. Two TD-754/G's can be operated on a cable link that extends to 40 miles. The pcm pulses from a TD-754/G are transmitted through Cable Assembly, Special Purpose, Electrical CX-11230/G or CX-4245/G that connects between each TD-206/G spaced between each mile of cable.

c. Technical Characteristics.

Number of audio channels . 6, 12, 24, or 48
 Compatible cable CX-11230/G or CX-4245/G
 Cable input/output data:
 Type of modulation PCM (Dipulse)
 Type of multiplexing Time-division-multiplex Cable input/output impedance .91 ohms
 Pulse width 200 ±30 nsec
 Pulse frequency..... 2304-kHz bit rate
 Bandwidth..... 1-MHz bandpass
 External equipment input/output data:
 Pulse amplitude 2 volts-rising to a peak amplitude of 0 volt from a base voltage of -2 volts

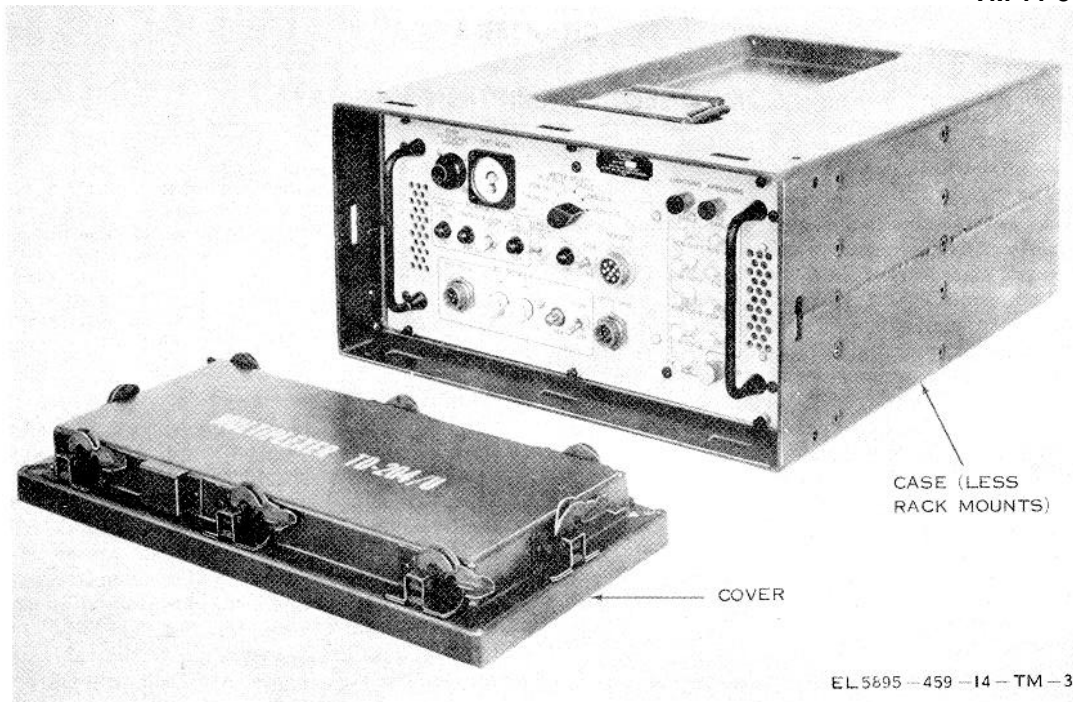

Figure 3-1. Multiplexer TD-204/U.

Pulse bit rate and pulse interval:

- 6-channel operation 288 kHz, 3.472 μ sec
- 12-channel operation 576 kHz, 1.736, μ sec
- Power requirement 109 to 121 volts ac, single phase, 47 to 420 Hz
- Power consumption 35 watts
- Power output 24 watts (maximum)
- Output regulated current to cable 38 ± 1.1 ma

3-3. Restorer, Pulse Form TD-206/0

a. Use. Restorer, Pulse Form TD-206/G (fig. 3-3) is a two-way unattended repeater for pcm cable systems. It is installed at 1 -mile intervals in the transmission cable to restore pcm pulse form and timing.

b. Technical Characteristics.

Input or output signal:

- Impedance..... 62 ohms
- Amplitude:
- Input signal 30 mV pp max., 10 mV pp min
- Output signal Leading edges of pulses swing 2 volts from zero to peak.
- Pulse type..... Binary dipulse
- Pulse rate 2,304 kHz
- Pulse width 205 nsec
- Power requirements 38-mA constant current supply (from TD-204/U or TD-754/G at either end)
- Operating temperature..... +125 °F to -60°F

3-4. Multiplexer TD-352/U

a. Use. Multiplexer TD-352/U (fig. 3-4) converts 12 four-wire voice-frequency channels to a tdm-pcm signal in its transmit section and vice versa in its receive section. Two TD-352/U's are used with a TD-204/U or TD-754/G to provide a 24-channel capacity. For secure operation, Adapter Connector UG-1923/G (fig. 3-5) shall be used with the TD-352/U.

b. Technical Characteristics.

Vf channels:

- Type 4-wire
- Number 12
- Channel sampling rate 8 kHz
- Type of multiplexing Time division
- Type of modulation..... Pulse code
- No. of pcm digits per channel sample 6

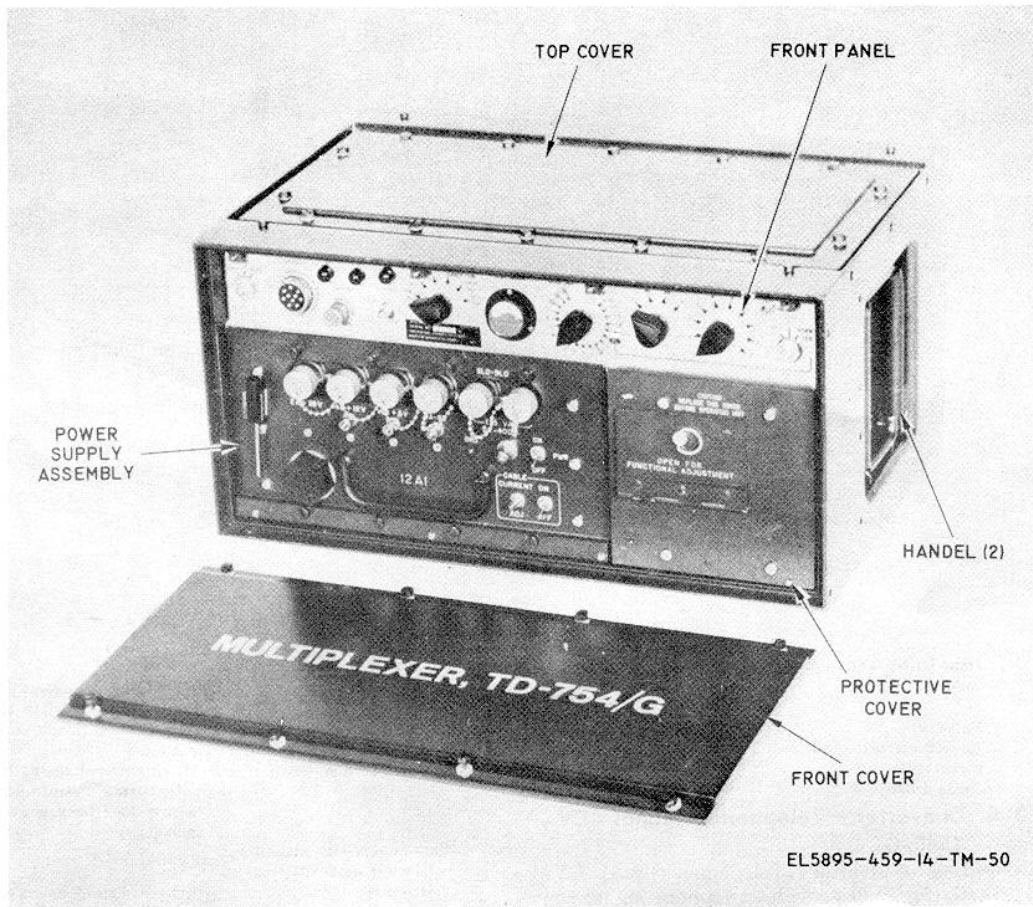
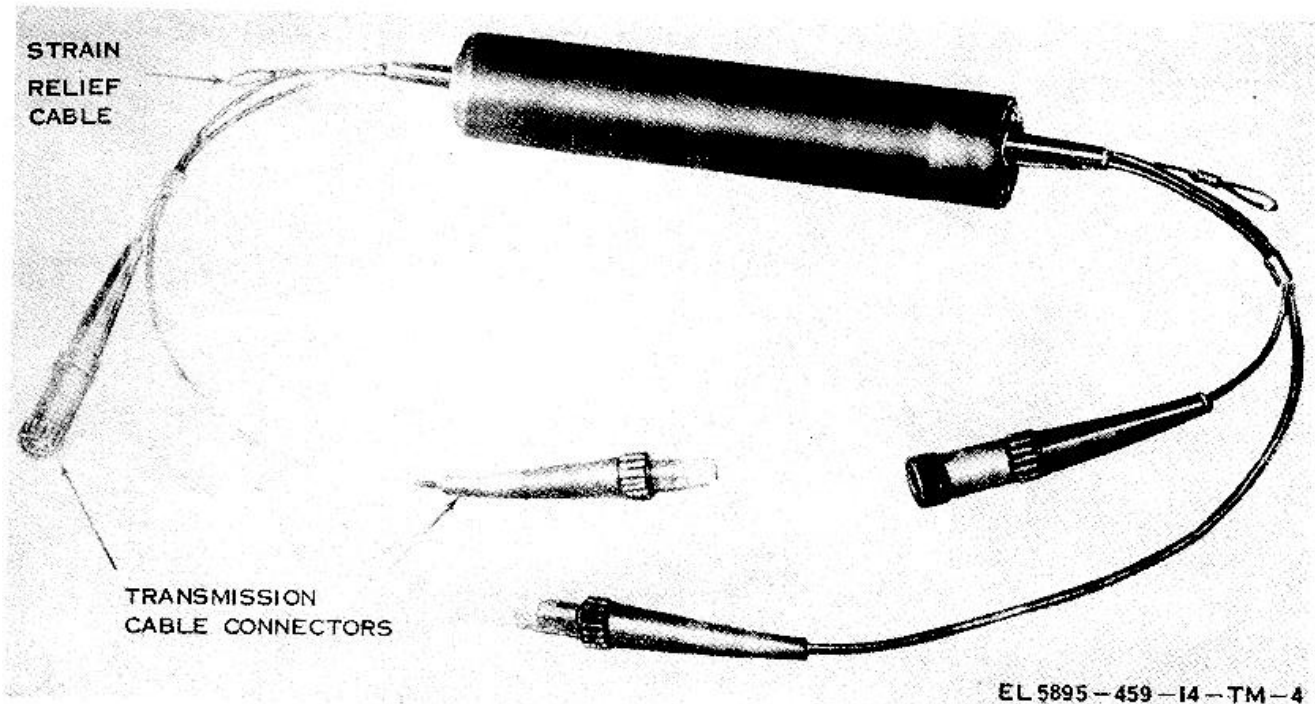

Figure 3-2. Multiplexer TD-7541G.

Channel interval	10.4) usec (96 kHz)	Signal-to-noise ratio plus crosstalk ratio	More than 53 dB
Frame interval	125 usec	Signal-to-noise ratio (F1A)	More than 55 dB
Addressing.....	2- or 4-kHz binary pattern (uses the last digit position of the last channel in each frame)	Signal-to-noise distortion ratio	More than 30 dB (24 on last channel)
Input voltage.....	109 to 121 volts, 47 to 63 kHz	Operating temperature.....	+125OF to -200 F
Power consumption	136 watts	Pcm input or output signal:	
Channel characteristics:.....		Impedance	91 ohms
Modulating bandwidth -	300 to 3,500 Hz	Amplitude	Pulses go positive to approximately 0 volt from a baseline of -2 volts.
Input for full modulation -4dBm test tone		Pulse type	Binary
Output for full modulation	-4-dBm (4-wire) +1 dBm (2-wire) (output is adjustable from -6 to +4 dBm)	Pulse rate and interval:	
Input and output impedance	600 ohms (balanced)	12-channel	576 kHz; 1.736 usec
		24-channel (interleaved).....	1,152 kHz; 868 usec
		Timing input or output signal:	



EL 5895 - 459 - 14 - TM - 4

Figure 3-3. Restorer, Pulse Form TD-206/G.

Impedance and amplitude.....	Same as pcm input or output signal
Pulse type	Sharp spike
Repetition rate and interval	576 kHz; 1,736 usec
Pulse width	150 usec (max.)

3-5. Converter, Telephone Signal CV-- 1548/G

a. Use. Converter, Telephone Signal CVI548/G (fig. 3-6) provides telephone signal conversion and hybrid facilities for 12 multiplex channels. Each channel contains one-way plug supervision and ringdown signaling conversion facilities, a hybrid for converting between 2-wire and 4-wire circuits, 4-wire straight-through patching, and switching for selecting combinations of these functions.

b. Technical Characteristics.

No. of channels.....	12
Operating modes (selected independently in each channel) 20 Hz signaling, 2-wire, Plug supervision signaling, 2-wire (one-way from originator to terminator) No signaling, 2-wire (hybrid only in use) No signaling, 4-wire (channel patched straight through 20 Hz signaling, 2-wire:	
From subscriber	20 Hz ringing voltage at 21 volts (18A3A panel) or 16 volts (18A3B panel) rms · minimum
To subscriber.....	20 Hz ringing voltage at 75 volts rms minimum (across four lines simultaneously)
Plug supervision signaling, (2-wire) modes:	
Originate (OR)	Switchboard trunk opens or closes T (tip) and R (ring) lead circuit in 18A3A or 18A3B panel.
Terminate (TE)	18A3A or 18A3B panel opens or closes T (tip) and R (ring) lead circuit in switchboard trunk.
Plug supervision:	
One way	18A3A and 18A3B
Two way	18A4
Multiplex terminal inputs and outputs, 4-wire (all signaling modes):	
From multiplex terminal	No tone or 1,600 Hz in band tone between -25 and 0 dBm
To multiplex terminal	No tone or 1,600 Hz in-band tone at -15 dBm (adjustable +5 dB)
Channel characteristics (2wire):	
Insertion loss.	4.5 dB maximum (250 to 3,500 Hz)

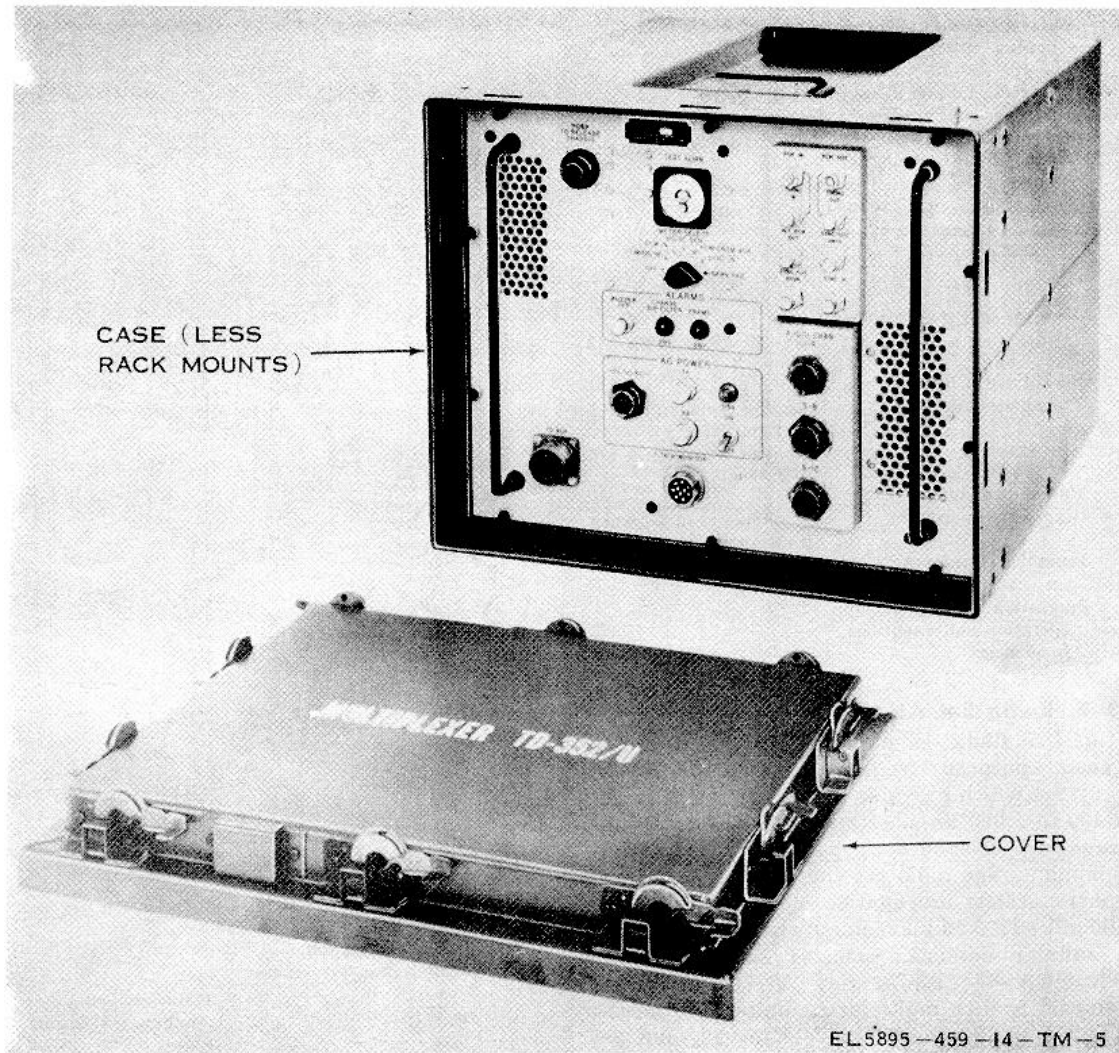

Figure 3-4. Multiplexer TD-852/U.

Input and output impedance.....	600 ohms (balanced to ground)
Input voltage.....	109 to 121 volts, 47 to 420 Hz
Power consumption	17 watts (idle), 60 watts (all channels ringing)
Operating temperature range.....	1250 F to -250 F

3-6. Converter, Telegraph Telephone Signal CV-425/U

a. Use. Converter, Telephone Signal CV- 425/U (fig. 3-7), converts incoming 20 Hz ringing signals to 1,232.5 Hz signals for telegraph signaling, and 20 Hz ringing signals to 1,600 Hz signals for telephone signaling over circuits that will not pass 20 Hz low frequency ringing signals. It also converts incoming 1,232.5 Hz and 1,600 Hz sig- nals to 20 Hz signals.

b. Technical Characteristics.

Input power requirement	115/230 Vac \pm 10%, 50 to 60 Hz -k3 Hz
Power consumption	25 watts maximum
Telegraph signaling frequency	1,232 .5 Hz
Telephone signaling frequency	1,600 Hz
Oscillator stability for telegraph and telephone sig-	

signaling frequencies	±10 Hz
Telegraph and telephone output power signaling level.....	0 dBm (-k2 dB)
Low frequency signal input 20 Hz	
20-Hz ring circuit types	Two wire and four wire
20-Hz ringing voltage.....	180 volts peak-to-peak
20-Hz circuit input impedance.....	1,500 ohms
20-Hz ringer circuit minimum voltage input requirement	50 volts peak-to-peak, at 20
Hz with two-wire or four-wire operation	
Receiver sensitivity on line side	Low, -30 dBm; High -48 dBm
Sensitivity on loop side	25 volts peak
Frequency limits	Telegraph signaling, 1,195 to 1,260 Hz
Telephone signaling, 1,570 to 1,630 Hz	
Maximum distortion	1%
Output line impedance.....	600 ohms ±10 % when transmitting
Input line impedance	8,000 ohms ±10% when receiving
Prevention of equipment operation on spurious frequencies	Time-delay guard circuit

3-7. Radio Set AN/GRC-143

a. Use. Radio Set AN/GRC-143 (fig. 3-8) is a general purpose, frequency-modulated tactical radio set which provides duplex operation in the 4,400 to 5,000 megahertz range with continuous wave (cw) power output capability of one kilowatt minimum. The radio set can be used for tropospheric scatter propagation modes x at ranges to 100 miles (160.90 kilometers) when matched with a suitable antenna, such as Antenna Group AN/TRA-37. Radio Set AN/GRC-143 is compatible with multiplexing units such as the TD-204/U and the TD-352/U for 12- and 24- voice channel pcm operation. Provisions are made for an order wire circuit which includes facilities that connect stations of a system on a party line basis. The basic radio set consists of three equipment cabinets: Transmitter, Radio T-961/GRC-143, Receiver, Radio R-1287/GRC-143, and Amplifier, Radio Frequency AM-6090/ GRC-143.

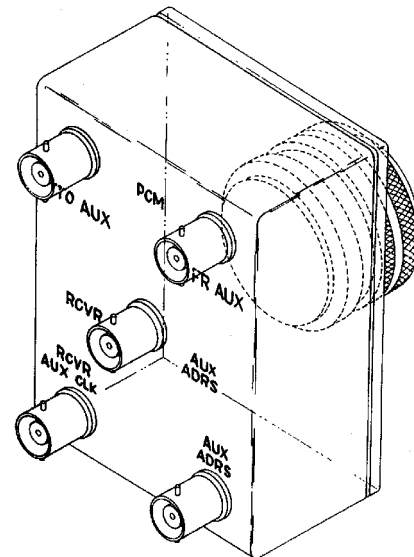

EL 5895-459-14-TM-51

Figure 3-5. Adapter Connector UG-1923/G

b. Technical Characteristics.

(1) Radio Set ANIGRC-143.

Type	Modular, solid state (except klystron)
Modes	(1) 12 channel pcm and order wire
(2) 24 channel pcm and order wire	
output power.....	Adjustable from 100 watts to 1.0 kilowatt
Frequency range.....	4400 to 5000 MHz
RF channels	6001
RF channel separation.....	100 kHz
Transmit/receive separation.....	90 MHz, minimum
Type of modulation.....	Frequency Modulation (FM)
FM deviation:	
12-channel pcm operation	250 kHz
24-channel pcm operation	500 kHz
Antenna requirement Antenna Group AN-/TRA-37	
Transmission lines.....	WR-187 flexible waveguide or equivalent
Distance range	Up to 100 miles dependent upon terrain and atmospheric conditions
Power requirement	115/230 Vac, 47 to 63 Hz, power factor 0.84, 5.37 kW
Temperature limits.....	OOF to +120OF
Weight.....	719 pounds
(2) Transmitter, Radio T-9611GRC-143.	
Frequency range.....	4,400 to 5,000 MHz

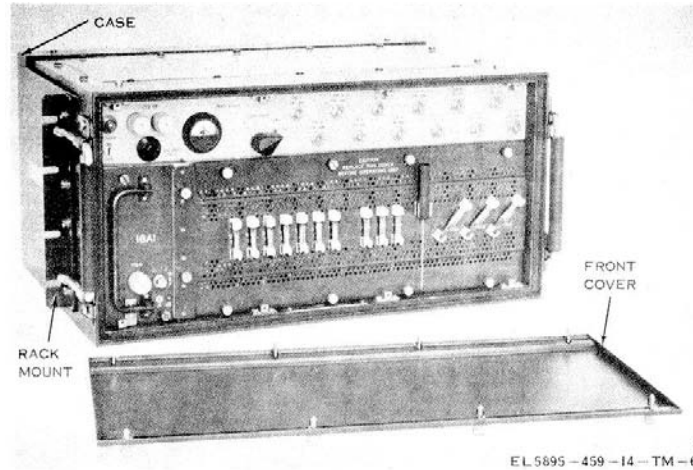

Figure 3-6. Converter, Telephone Signal CV-1548/G.

Power output.....	150 mW nominal
Output impedance	50 ohms
Output connector	Type N
Local oscillator:	
Type	Synthesizer source, crystal controlled
Synthesizer frequency	
range	284.375 to 303.125 MHz
Frequency multiplication.....	16
Local oscillator frequency	
range	4,550 to 4,840 MHz
Frequency selection steps	100 kHz
PCM video input:	
Waveform	Composite 12 or 24 channel pcm
Level	1.0 to 4.0 volts peak-to-peak
Impedance	50 ohms
Order wire circuits:	
Frequency response	300 to 1,700 Hz
Distortion.....	5 percent, maximum
Peak limiting compression:	
at 0 dBm input level 0.4 dB maximum	
at +15 dBm input level . 10 dB +3 Db	
Order wire input signals:	
Recovered order wire ...	-4 dBm into 600 ohms
Local handset ..	0 dBm into 50 ohms
Receiver (emergency order wire	11 dBm into 50 ohms
Remote telephone set	0 dBm into 600 ohms
Through path order wire	-4 dBm into 600 ohms
Order wire output signals:	
Local handset	-18 +3 dBm at 150 ohms
Remote telephone set	-14 +3 dBm into 600 ohms
Transmitter order wire	0 +3 dBm at 600 ohms
Through path order wire.....	-4 +3 dBm at 600 ohms
Metering.....	Integral metering provided for monitoring and adjustment
Alarm indicators	Seven visual alarms are provided on the bans mister meter panel to monitor the operation of the transmitter circuits. A CNTRL ALARM is also provided on the transmitter meter panel to indicate the operational status of the radio set.
Status indicators.....	Two status indicators are provided on the transmitter meter panel to indicate presence or absence of test and order wire ring signal in radio set

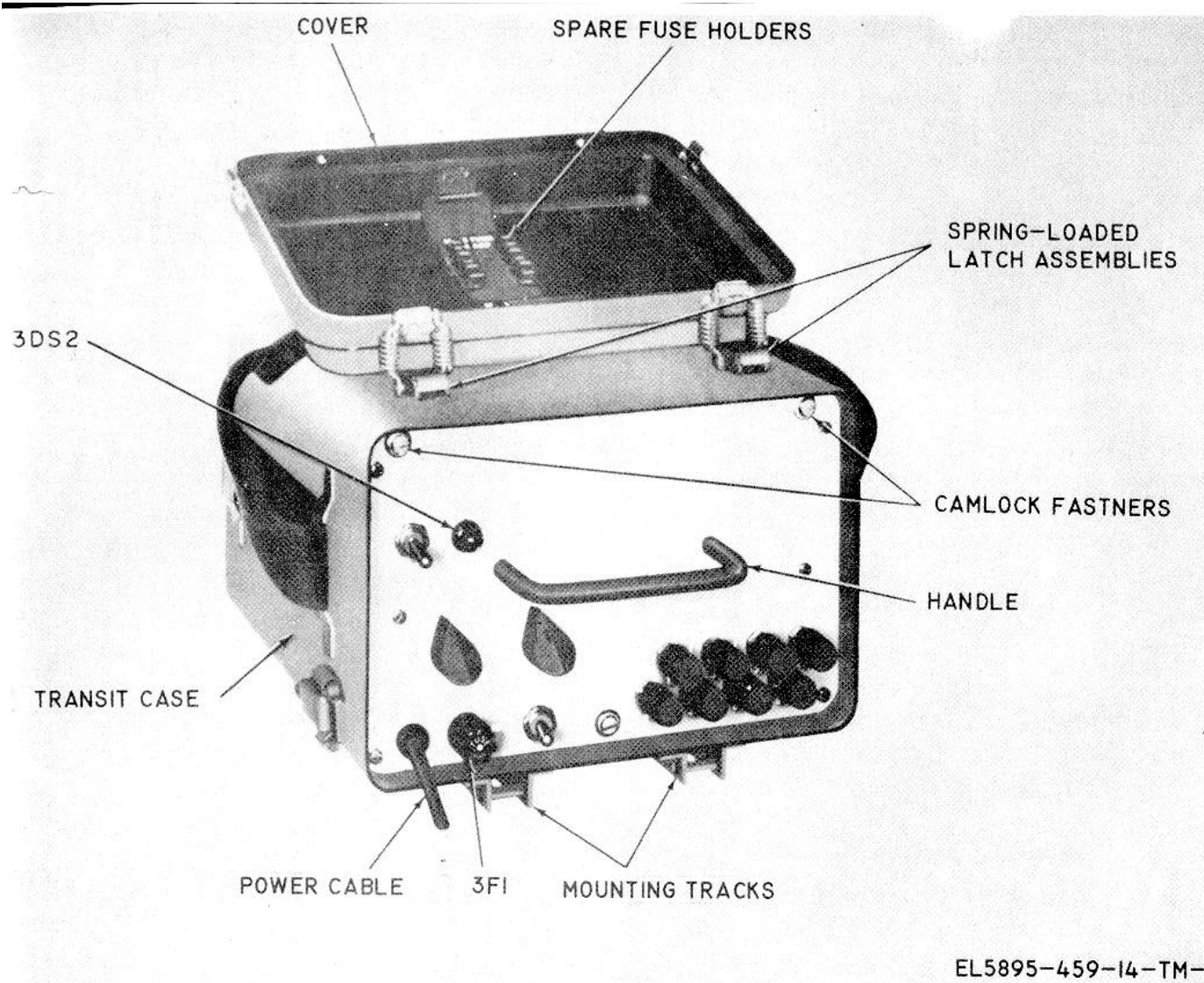

Figure 3-7. Converter, Telegraph-Telephone Signal CV-425/U, front view of panel.

Power requirement115Vac,+5, 3 amperes, 275 watts, power factor 0.85, single phase, 47 to 63 Hz
 Temperature limits.....0°F to +120°F

(3) Receiver, Radio R-1287/GP C-143.

TypeDual diversity, single conversion superheterodyne
 Diversity modeSpace diversity
 Type of combiningIF-predetection with IF squelch and combined signal age
 Noise figure (4,400 to 5,000MHz)5.5 dB maximum
 RF input connectionWaveguide flange Sensitivity threshold
 Operated as single receiver12 channels 24 channels -100 dBm -97 dBm
 Operated as dual receiver with equal rf inputs . -103 dBm -100 dBm
 Frequency range4,400 to 5,000 MHz
 Response to spurious signals80 dB below rf channel response
 Local oscillator:
 TypeSynthesizer source, crystal controlled
 Synthesizer frequency
 range284.375 to 303.125 MHz
 Frequency multiplication16 (220 MHz added or subtracted)
 Local oscillator frequency range4,330 to 5,070 MHz
 Adjustment steps100 kHz
 Intermediate frequency70 MHz
 Intermediate frequency bandwidth: 12-channel operation 750 kHz +10 percent at 3 dB points
 24-channel operation1.5 MHz +10 percent at 3 dB points
 Output level1 volt peak-to-peak
 Output waveform12- or 24-channel pcm and order wire
 Output impedance50 ohms +10 percent
 MeteringIntegral metering provided for monitoring and adjustment
 Alarm indicatorsFive visual alarms are provided on the receiver meter panel to monitor the operation of receiver circuits.

Power requirement115 Vac, +5, 2.75 amperes, 295 watts, power factor 0.91, 47 to 63 Hz, single phase
 Temperature limits0 °F to + 120 °F

(4) Amplifier, Radio Frequency AM-6090/ GPC-143.

Type4 cavity, tunable klystron
 KlystronVA 888D
 Beam focusingPermanent magnet
 Klystron coolingForced air
 High temperature interlock Opens at 260 CC
 Input level50 mW minimum (zero attenuation)
 Input level adjustment.....Internal variable attenuator
 Input vswrNot greater than 2:1
 Input impedance:50 ohms
 Input connectorType N
 Frequency range4,400 to 5,000 MHz
 Power outputAdjustable from 100 to 1,000 watts
 Output vswr2:1 maximum
 Output connectorWaveguide flange
 Nominal beam voltage7,500 volts (adjustable)
 Beam current.....0.5 ampere (nominal)
 Metered functionsFour meters are provided on power amplifier meter panel to monitor the power amplifier klystron voltages, current, and running time. One meter is provided on the power amplifier meter panel to monitor the power amplifiers input and output signal levels.
 Alarm indicatorsEight visual alarms are provided on the power amplifier meter panel to monitor the operation of power amplifier circuits.

Power requirements 115/230 Vac + 10 %, power factor 0.82, 4.75 1`W (total), line A to neutral 24.5 amperes, line B to neutral 24.0 amperes

Temperature limits0°F to + 120 °F

(5) Synthesizer, Electrical Frequency. Transmitter, Radio T-961/GRC-143 and Receiver, Radio R-1287/GRC-143 use identical electrical frequency synthesizers. Detailed performance characteristics are listed below:

TypeModular, solid state, crystal controlled, phase locked
 Frequency range284.375 to 303.125 MHz, in 6.250 kHz steps
 Number of frequencies3001
 Frequency stability1 x 10⁻⁷ per day, or 1 x 10⁻⁶ per 30 days
 Power input 50 watts at 110 volts, 50 to 400 Hz (60 Hz typical), single phase, two wire
 Warmup time.....30 minutes for frequency accuracy of 5 parts in 10⁷ -Output power 20 mW +1 dB into 50 ohm resistive load
 Output impedance59 ohms
 Output protection.....No damage from open or short circuit
 Spurious am sideband output..... 80 dB below desired output (minimum)
 Harmonic levels: Second harmonic 20 dB below desired output (minimum)

Third harmonic	30 dB below desired output (minimum)
All others	40 dB below desired output (minimum)
Lamp indications.....	Power supply and modules
Remote indications	Phase lock, oven, and out-put level

3-8. Radio Set AN/GRC-106A

a. Use. Radio Set AN/GRC.-106A (fig. 3-9) is a high frequency (hf), single-sideband (ssb) receiving-transmitting unit. -It is used for receiving and transmitting upper-sideband (usb) voice and usb compatible amplitude-modulated (compatible am) signals in a simplex operation over a 50 mile range. Conventional double-sideband amplitude-modulated signals can be received, but not transmitted. The AN/GRC-106A is employed to align Radio Set AN/GRC-143, and provides communications while the radio facilities are in transit.

b. Technical Characteristics.

(1) Receiver-Transmitter, radio RT-834/GRC.

Number of electron tubes.....	2
Number of transistors	151
Frequency range.....	2.0 to 29.999 MHz
Selectively tuned operating channels.....	280,000
Channel frequency separation	kHz
Types of transmission.....	Upper sideband and usb compatible AM, CW, FSK, and narrow FSK
Types of reception.....	Usb, compatible and conventional, double-side-band, and AM, CW, FSC and narrow FSK
Type of control.....	Crystal-controlled synthesizers referenced to a highly stable 5 MHz internal standard
Primary voltage	27 ±3 volts direct current
OVEN ON.....	16.2 watts nominal initially; 2.7 watts stabilized
STAND BY	14 watts nominal CW, AM, SSB, NSK, or FSK 36 watts nominal receive; 45 watts nominal transmit
Rf power output	0.1 watt (pep) nominal
Type of receiver	Superheterodyne with triple conversion
Receiver intermediate frequency	First, 20 or 30 MHz Second, 285 MHz Third, 1.75 MHz
Bandwidth.....	32 kHz as established by crystal filter

(2) Amplifier, Radio Frequency AM-3349/GRC-106. AM-3349/GRC-106 is a linear radio frequency power amplifier. Its final stage matches a 15-foot whip antenna.

Number of electron tubes.....	3
Number of transistors	10
Frequency range	2.0 to 29199 b4Hz
Input impedance	50 ohms
Output impedance (when antenna coupler assembly 2A3 is properly tuned):	
Output No. 1	50 ohms
Output No. 2.....	To match 16-foot whip antenna
Rf power input	Nominal 0.1 watt (pep); maximum 0.125 watt (pep)
Primary voltage	27 ±3 volts direct current
Power requirements:	
Standby	250 watts (maximum)
Operate	250 watts (maximum)
Transmit:	
Two-tone	1,000 watts (nominal)
Voice.....	800 watts (average)
Power output:	
Ssb.....	400 watts (pep) +2, -1 decibel
Compatible am	400 watts (pep) +2, -1 decibel carrier is at nominal 70 watts)
CW or FSK.....	200 watts (average) nominal 2, -1 decibel
Antenna.....	15-foot whip (nominal 50 ohms)
Effective range	50 mfles (80.45 kilometers) nominal (groundwave); 100 to 1,500 miles (sky. wave), depending on terrain, frequency, antenna, time and atmospheric conditions

3-9. Power Supply PP-4763A/GRC

a. Use. Power Supply PP-476SA/GRC (fig. 3-10) converts either 115 or 230 volts alternating current (ac) to direct current (dc) to provide a power source for any type of load within its voltage and current rating.

b. Technical Characteristics.

Power input

Voltage.....	115volts -k10%at47to6S Hz, or 230 volts ±10% at 47 to 63 Hz
Phase.....	Single
Current (full load).....	23 amperes at 115 volt input; 11.5 amperes at 230 volt input
Voltage.....	Variable from 27 to 29 volts dc (28-volt operation)
Current (full load).....	50 amperes, continuous
Ripple voltage	1.0 % (root-mean-square)
Voltage regulation.....	±0.5 %
Surrounding operating temperature.....	-4 OF (-20 C) to 131 F (55 *C)

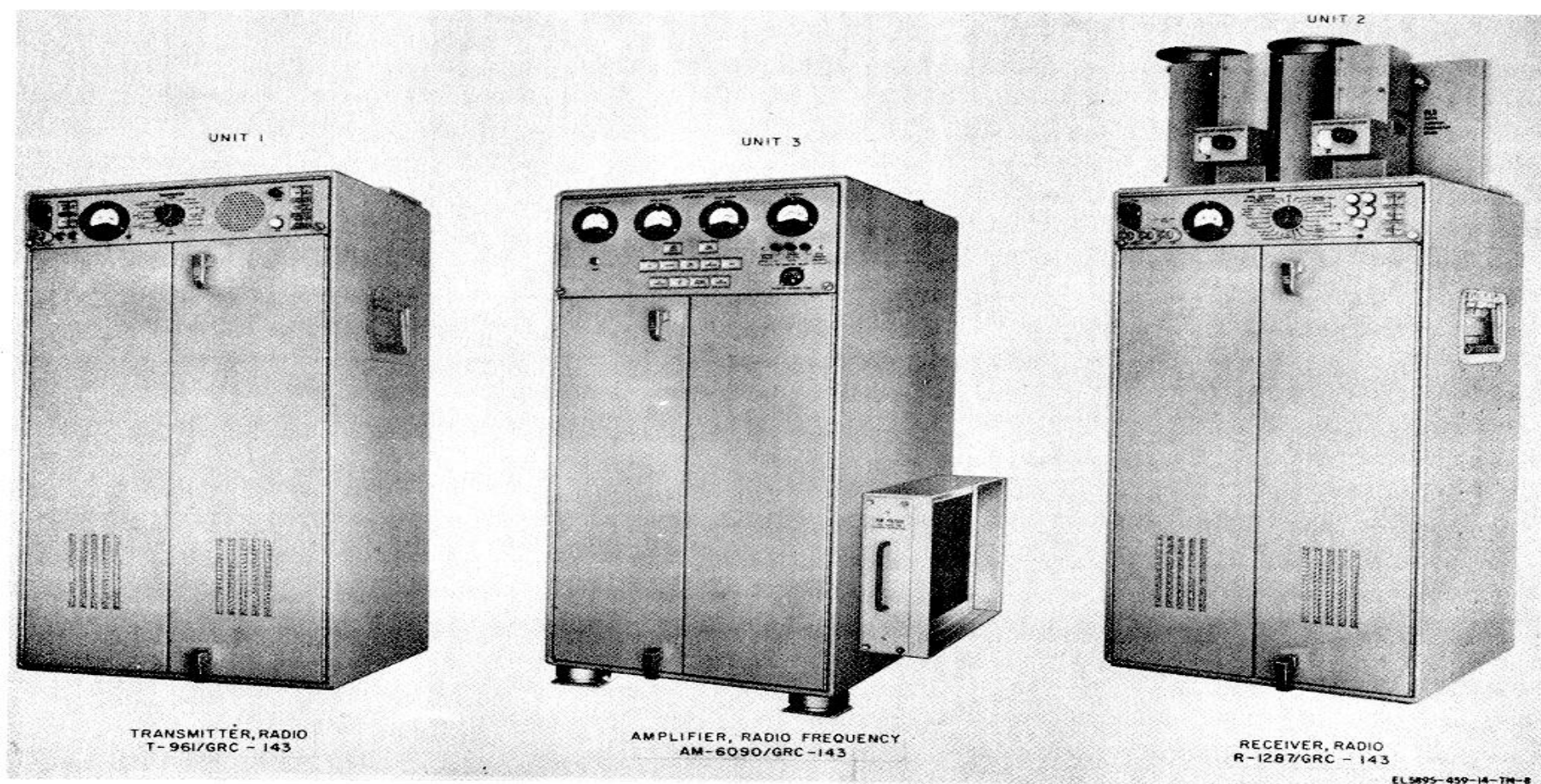
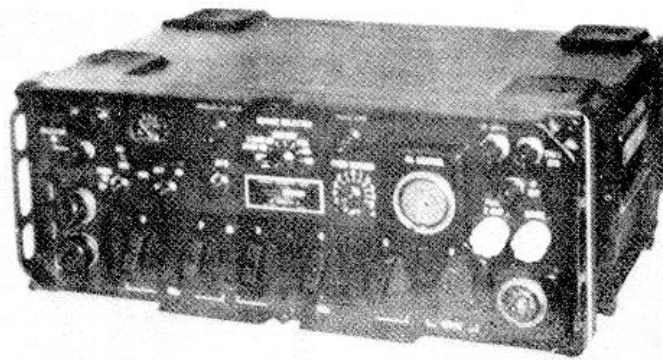
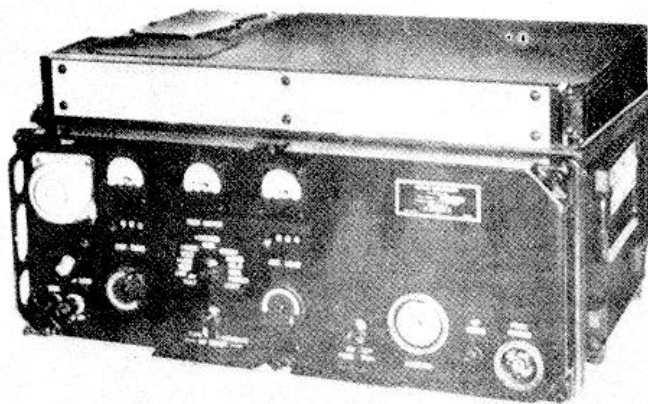

Figure 3-8. Radio Set AN/GRC-143.



RT-834/GRC



AM-3349/GRC-106

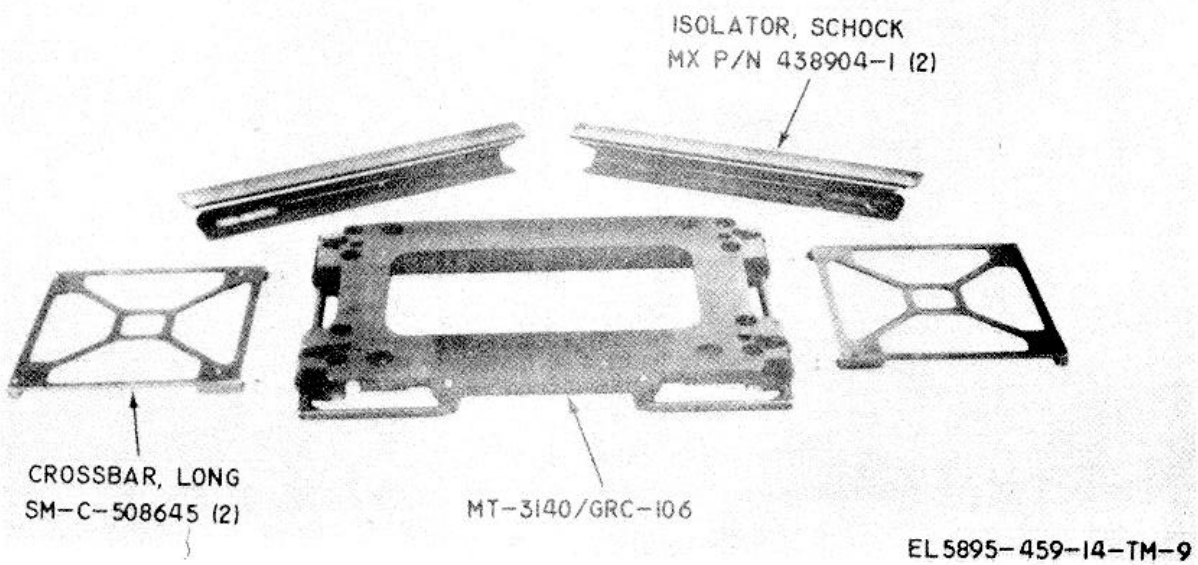

EL 5895-459-14-TM-9

Figure 3-9. Radio Set AN/GRC-106A.
3-12

Meters:

- Output current meter, type, MR36WO80DCAAR..0 to 80 amperes
- Output voltage meter, type, MR36WO50DCVVR..0 to 50 volts

Solid-state devices:

- Semiconductor device, diode..... 24 each
- Transistor..... 4 each
- Semiconductor device, controlled rectifier 3 each

3-10. Regulator, Voltage CN-514/GRC

a. Use. Regulator, Voltage CN-514/GRC (fig. 3-11) provides regulated ac power from either a central power source or an engine generator set.

b. Technical Characteristics.

Input:

- Voltage 95 to 135 volts
- Frequency..... 47.5 to 63 Hz

Output:

- Automatic regulation . 115 volts ± 1%
- Current..... 0 to 43 amperes
- Capacity 5 kilovolts
- Efficiency Better than 98 %

3-11. Antenna Group AN/TRA-37

a. Use. Antenna Group AN/TRA-37 (fig. 3-12) is intended for use as the transmitting and receiving elements in a tactical tropospheric communication

system. It includes two 10-foot diameter, horn fed parabolic reflectors. One is used for transmitting and receiving. The other is used only for receiving.

b. Technical Characteristics.

Type	Horn-fed, 10 foot parabolic reflector
Feed system.....	Single horn, orthogonally polarized
Horn-polarization isolation	40 dB
Frequency range.....	4.4 to 5.0 GHz
Beamwidth.....	1.5 ° nominal
Gain at 5.0 GHz.....	40 dB
Gain at 4.4 GHz.....	39 dB
Power handling capacity	2 kW cw at maximum vswr
Vswr	1.5 maximum
First sidelobe response..	At least 19 dB down
Transmission Line:	
Type	WR.187 flexible wave-guide
Attenuation between 4.4 and 5.0 GHz	1 dB per 26 ft
Elevation adjustment range	-5° to +15°
Azimuth adjustment range	±30°
Positioning controls.....	Manually operated
Isolation between channels	40 dB minimum
Operational environment:	
Wind velocity.....	50 mph
Ice loading.....	1/2-inch thick coating

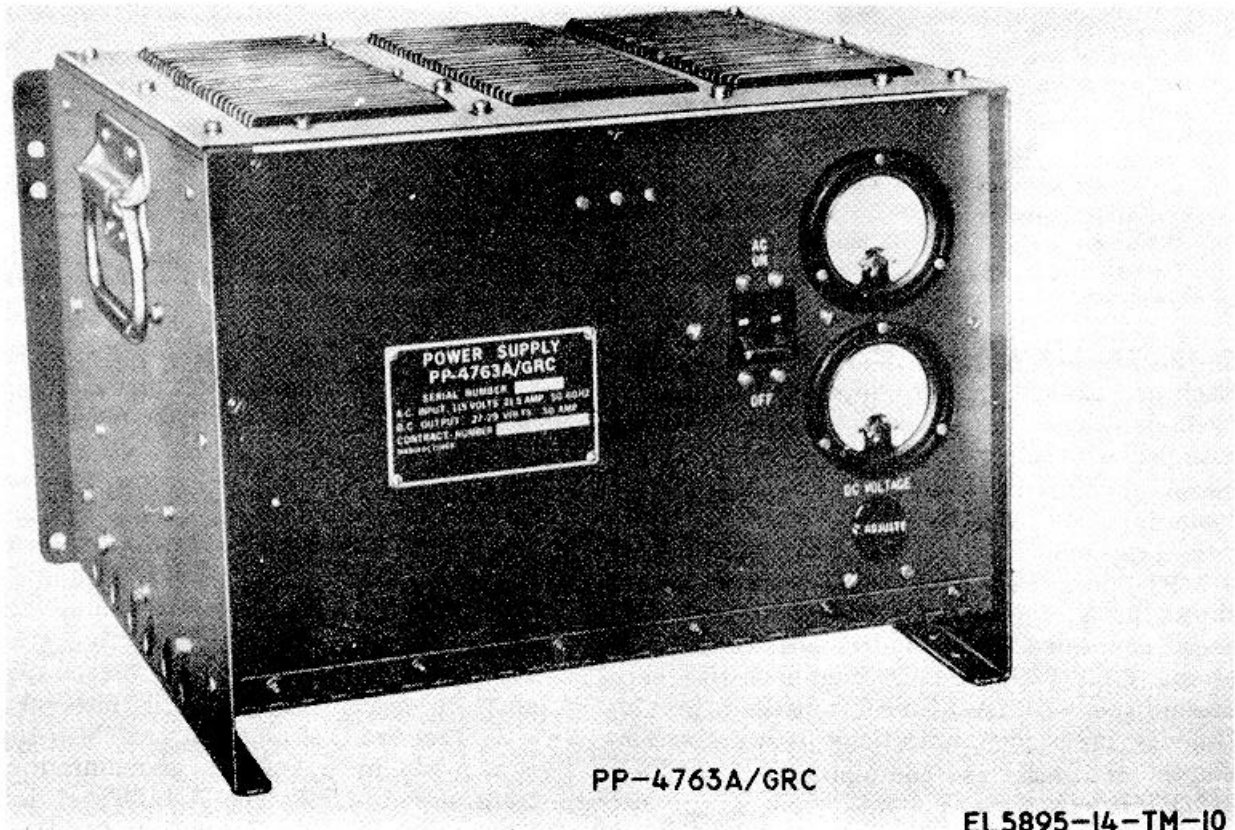

PP-4763A/GRC

EL5895-14-TM-10

Figure 3-10. Power Supply PP-4763A/GRC.

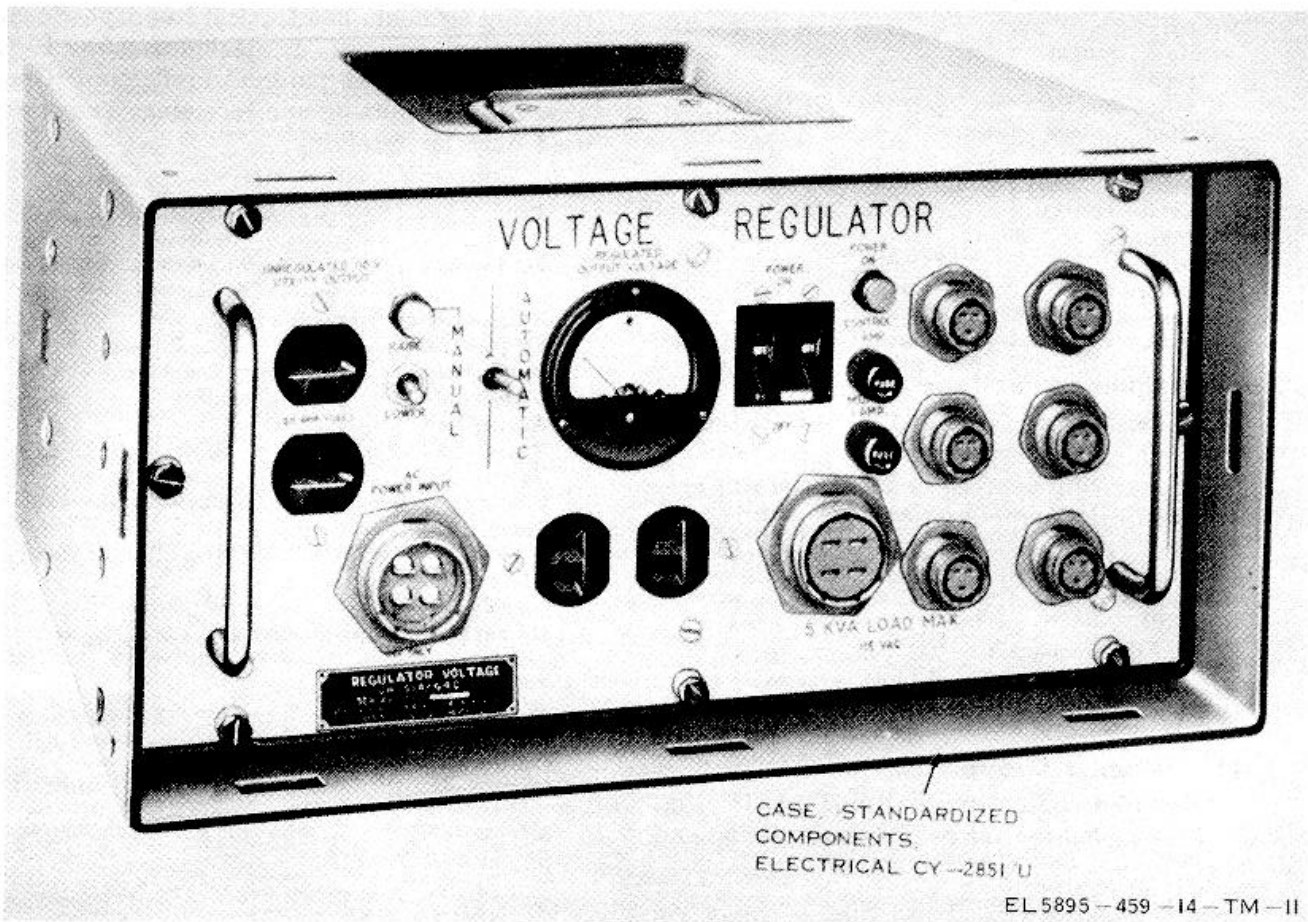

Figure 3-11. Regulator, Voltage CN-514/GRC.

Temperature range.... -65°F (-50°C) to +155°F (+70° C)

Survival environment:

Wind velocity..... 75 mph

Iceloading..... ½-inch thick coating

Antenna height 15 feet (to vertex of antenna)

3-12. TA-312/PT and LS-147C/FI

Each assemblage contains local communication facilities. These facilities may be interconnected with field wire between assemblages to establish a means of direct communications within an area communication system.

a. Telephone Set TA-812/PT. The TA-312/PT (less carrying case) is mounted as shown in A, figure 3-13. The telephone cord shown connected to the binding posts is not part of the TA-312/PT, but is supplied with each assemblage. The TA-312/PT is used to provide two-way radio communications between assemblages or locations containing other TA-312/PT's.

b. Intercommunication Station LS-147C/FI. The LS-147C/FI shown in B, figure 3-13 is a two-way voice communication facility. It may be used

between assemblages (connected by field wire) or locations containing other LS-147/FI's.

3-13. Transmission Cable and Test Set, Telephone AN/PTM-7

a. Cable Assembly, Special Purpose, Electrical CX-4245/G or CX-11230/G (transmission cable) is required for pcm cable transmission between assemblages containing TD-204/U's or TD-754/G's. The transmission cable can be installed on the ground (including submerging in up to 3 feet of water), or installed on poles or trees. When the transmission cable is used, a Restorer, Pulse Form TD-206/G (para. 3-3) must be used at every 1-mile interval, and a Multiplexer TD-204/U (para. 3-1) or TD-754/G (para. 3-2) must be used at every 40-mile interval.

b. Test Set, Telephone AN/PTM-7 (fig. 3-14) is required by a lineman to maintain the pcm transmission cable. The AN/PTM-7 is used in conjunction with the TD-204/U or TD-754/G to localize troubles in a pcm transmission cable.

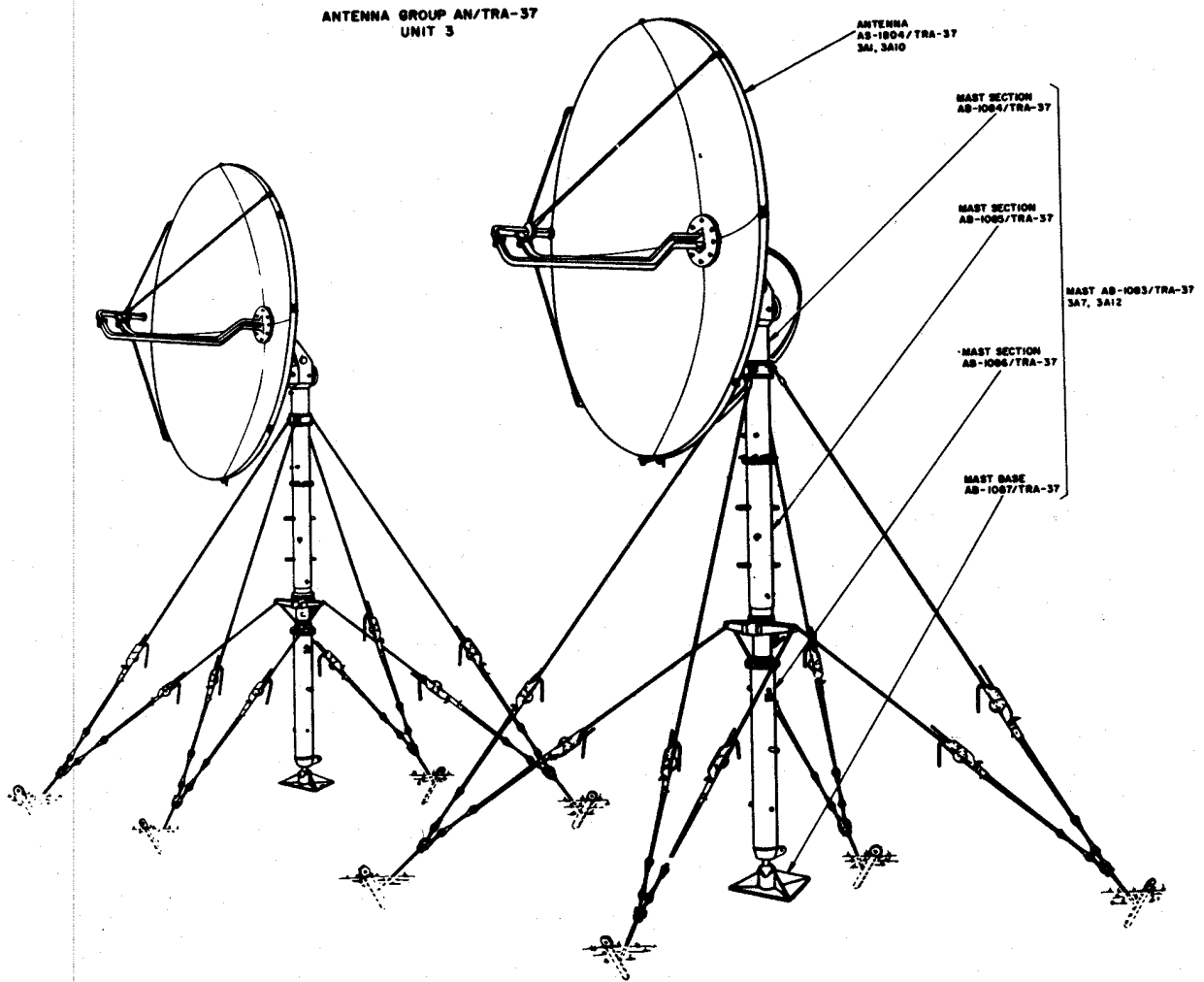

E L 5895 - 459 - 14 - T M - 12

Figure 3-12. Antenna Group AN/TRA-37.
3-15

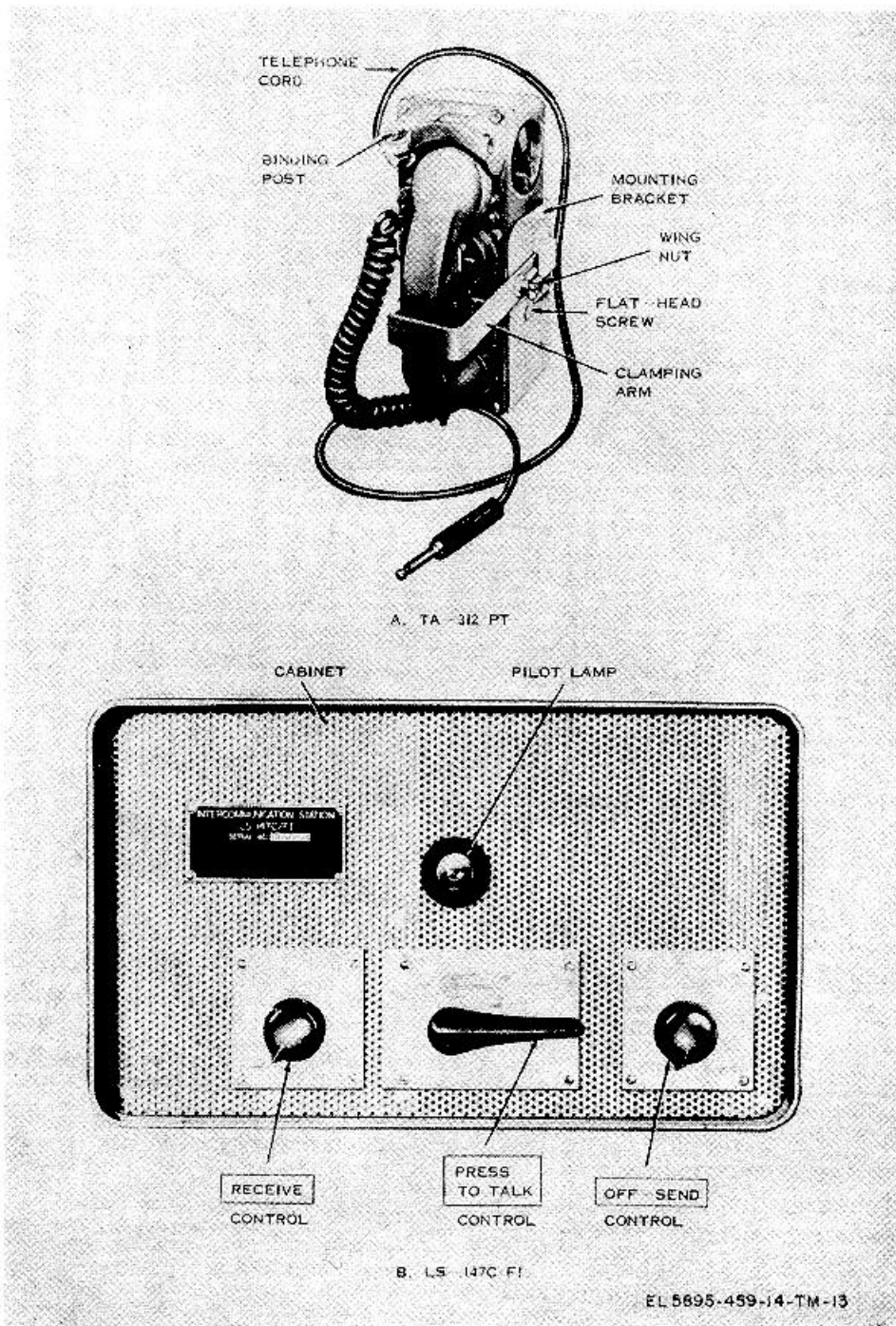

Figure 3-13. Telephone Set TA-812/PT and Intercommunication Station LS-147C/FI.

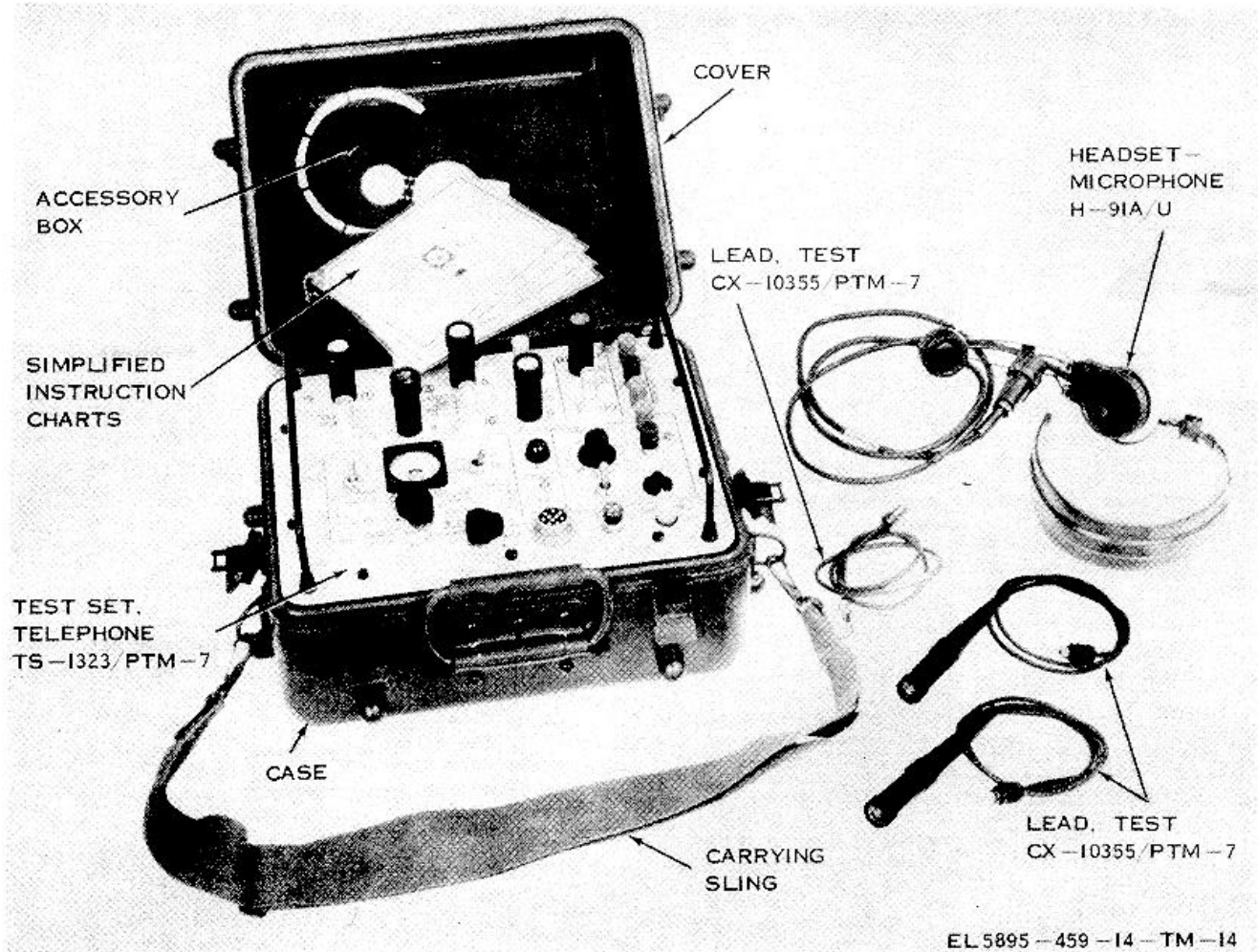

Figure 3-14. Test Set, Telephone AN/PTM-7.
3-17

**CHAPTER 4
ASSEMBLAGE DESCRIPTION AND DATA**

4-1. General Characteristics

a. The assemblies of the Tropospheric Scatter Tactical Radio Relay System are air or vehicular transportable. These assemblies utilize fully insulated and weatherproof modified lightweight field and module shelters of aluminum stressed skin foam-core construction. Chart 4-1 indicates the shelter type number, and the shelter facility type number (modified shelter) for each assembly and the type of vehicle required for transportation.

b. The dimensions of the shelter facilities are the same as the shelter and are provided in chart 4-2.

c. All components of the assemblies are mounted in equipment racks that are secured to the floor and walls of the shelter facilities. Mounting and storage facilities are provided in each assembly for storing signal and power cable reels and spare parts. Fluorescent light fixtures are mounted on the ceilings of the assemblies to provide primary lighting. Incandescent lights provide lighting when the temperature is too low for the fluorescent lights to operate. The fighting in each assembly may be controlled by a door interlock for blackout operations, or by-passed if blackout conditions are not required. All signal and power connections are made through entrance boxes and routed through ductwork on the walls of the assemblies. Each assembly has facilities for local telephone and intercommunication facilities. The interior temperature of the assemblies may be maintained relatively constant by the heaters and exhaust blowers, and by the use of trailer-mounted air conditioners. Exterior views of each assembly are provided in figures 4-1 through 4-7.

d. Power (115 ± 11.5 volts, 50 to 60 Hz, single phase) for any of the assemblies may be supplied from a central power source or from an appropriate trailer-mounted power source. The trailer-mounted power source associated with each assembly is indicated in chart 4-3.

Chart 4-1. Shelter Characteristics

Shelter type No.	Shelter facility type No.	Assembly type No.	Vehicle (ton)
S-318/G	S-300/TCC-60	AN/TCC-60	3/4
S-280/G	S-301/TCC-61	AN/TCC-61	2-1/2
S-250/G	S-381/TCC-69	AN/TCC-69	1-1/4
S-250/G	S-336/TRC-112	AN/TRC-112	1-1/4
S-280/G	S-338/TRC-121	AN/TRC-121	2-1/2

Chart 4-2. Shelter Dimensions

Shelter type No.	Maximum outside dimensions (in.)		
	Length	Width	Depth
S-250/G	85	79-1/4	70
S-280/G	147	87	83
S-318/G	79	73-1/2	68

Chart 4-3. Power Sources

Nomenclature	Assembly
Generator Set, Gasoline or Engine, Trailer Mounted PU-628/G	AN/TCC-60 AN/TCC-69
Generator Set, Gasoline Engine, Trailer Mounted PU-629/G	AN/TCC-61
Generator Set, Gasoline Engine, Trailer Mounted PU-332A/G	AN/TRC-112
Generator Set, Gasoline Engine, Trailer Mounted PU-405/G	AN/TRC-121

4-2. Terminal Sets, Telephone AN/TCC-60 and AN/TCC-69

a. Use. Terminal Set, Telephone AN/TCC-60 or AN/TCC-69, in combination with Radio Terminal Sets AN/TRC-112, AN/TRC-121, and Terminal Telephone AN/TCC-61, will supplement a 24-channel tropospheric scatter system. Typical applications of the AN/TCC-60 or AN/TCC-69 are shown in B, figure 6-2. Interiors of the AN/TCC-60 are shown in figures 4-8 through 4-10. Interiors of the AN/TCC-69 are shown in figures 4-11 through 4-15.

b. Major Characteristics.

Possible system applications:

12-channel cable terminal	2
24-channel cable terminal	1

Power consumption (maximum):

AN/TCC-60.....	2,630 watts
AN/TCC-69.....	2,910 watts

Weight:

AN/TCC-60.....	2,100 lbs
AN/TCC-69.....	2,300 lbs

4-3. Terminal Set, Telephone AN/TCC-61

a. Use. Terminal Set, Telephone AN/TCC-61 (fig. 4-2), in configuration with Telephone Terminals AN/TCC-60/69 and Radio Terminal Sets AN/TRC-112/121, can be part of a complete tropospheric scatter terminal. Tactical tropospheric transmissions with a 24-channel traffic capacity can be provided for Army Command Systems.

Figure 6-2 shows the AN/TCC-61 in application with cable and radio communications. Interiors of the AN/TCC-61 are shown in figures 4-16 through 4-18.

b. Major Characteristics.

Possible system applications	
12-channel cable terminal.....	8
24-channel cable terminal.....	4
Power consumption	6,086 watts
Weight.....	2,875 lbs

4-4. Radio Terminal Set AN/TRC-112

a. Use. Radio Terminal Set AN/TRC-112 (figs. 4-4 and 4-5) can be part of a complete tropospheric scatter terminal when employed with Radio Terminal Set AN/TRC-121 and Telephone Terminals AN/TCC-60/69, or AN/TCC-61. A typical, tropospheric scatter terminal configuration with a 24-channel capacity is shown in figure 6-2. Interiors of the AN/TRC-112 are shown in figures 4-19 through 4-24.

b. Major Characteristics.

Power consumption (maximum)	6,045 watts
Weight.....	1,580 lbs

4-5. Radio Terminal Set AN/TRC-121

a. Use. Radio Terminal Set AN/TRC-121 (figs. 4-6 and 4-7) provides split-terminal facilities in an Army and Corps Command System. When configured with Telephone Terminals AN/TCC-60/69 or AN/TCC-61, 24-channel tactical tropospheric scatter communications can be established. A typical scatter-terminal configuration is shown in figure 6-2. Interiors of the AN/TRC-121 are shown in figures 4-25 through 4-29.

b. Major Characteristics.

Power consumption (maximum)	14,180 watts
Weight.....	5,150 lbs

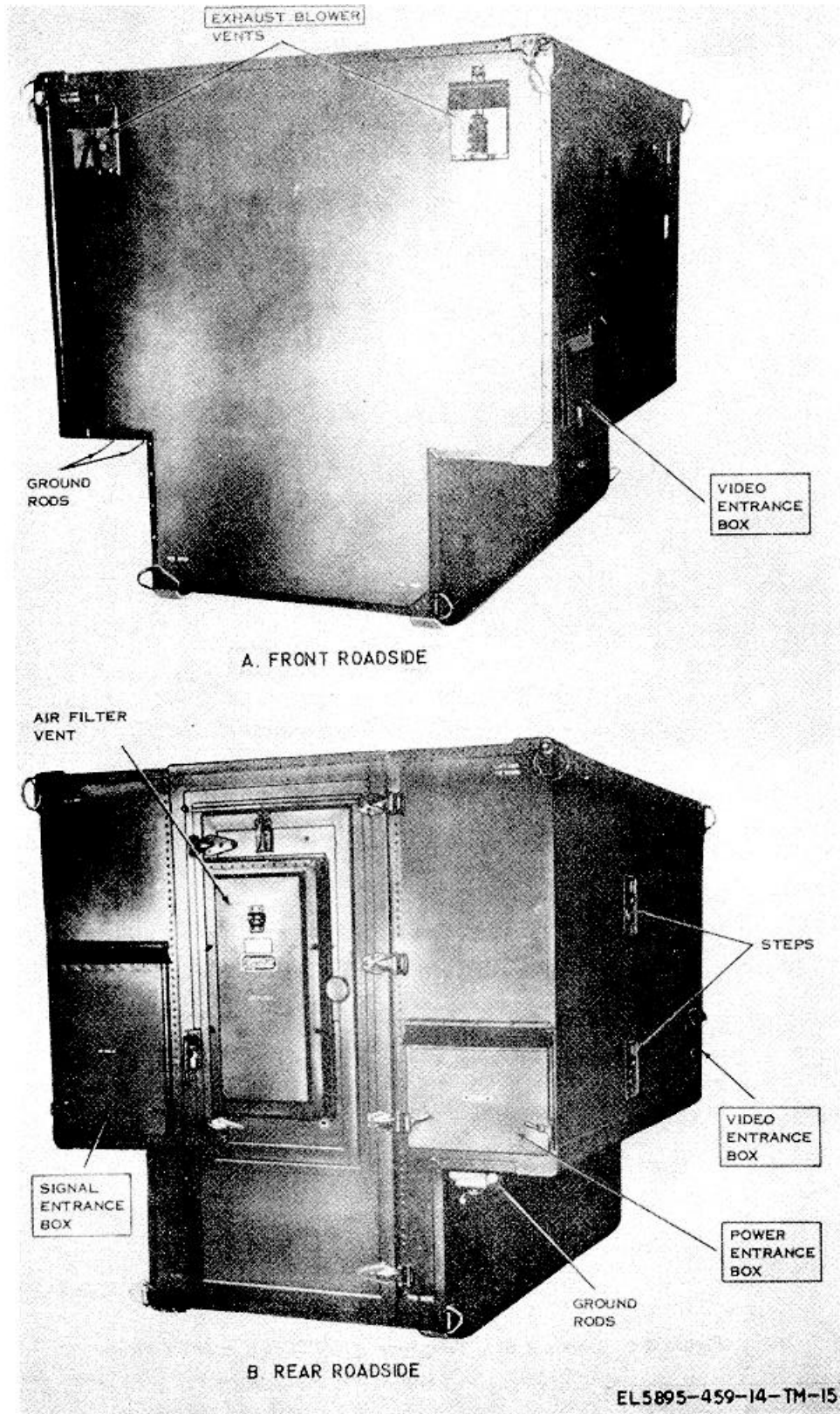

Figure 4-1. Terminal Set, Telephone AN/TCC-60, exterior views.

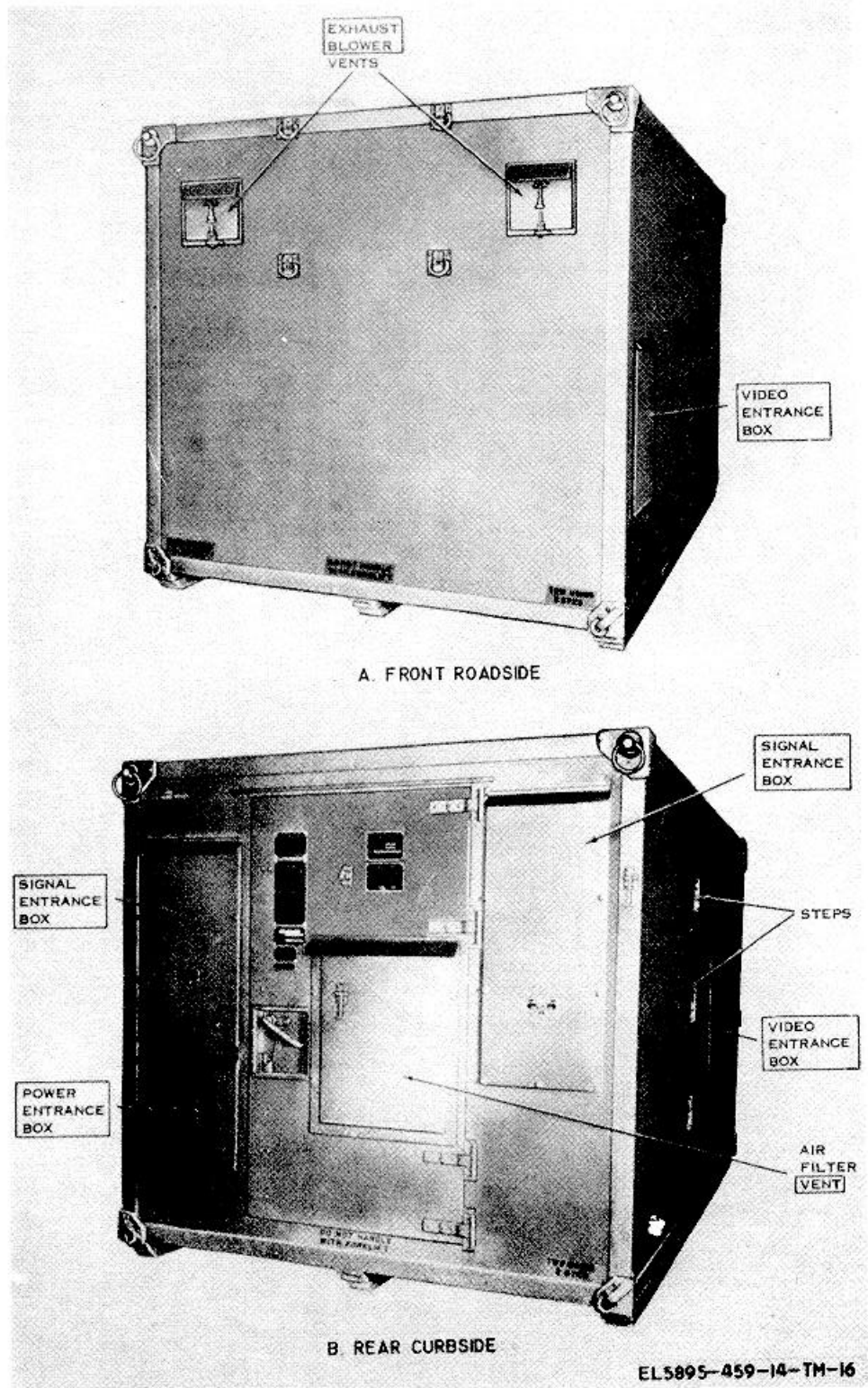

Figure 4-2. Terminal Set, Telephone AN/TCC-61, exterior views.

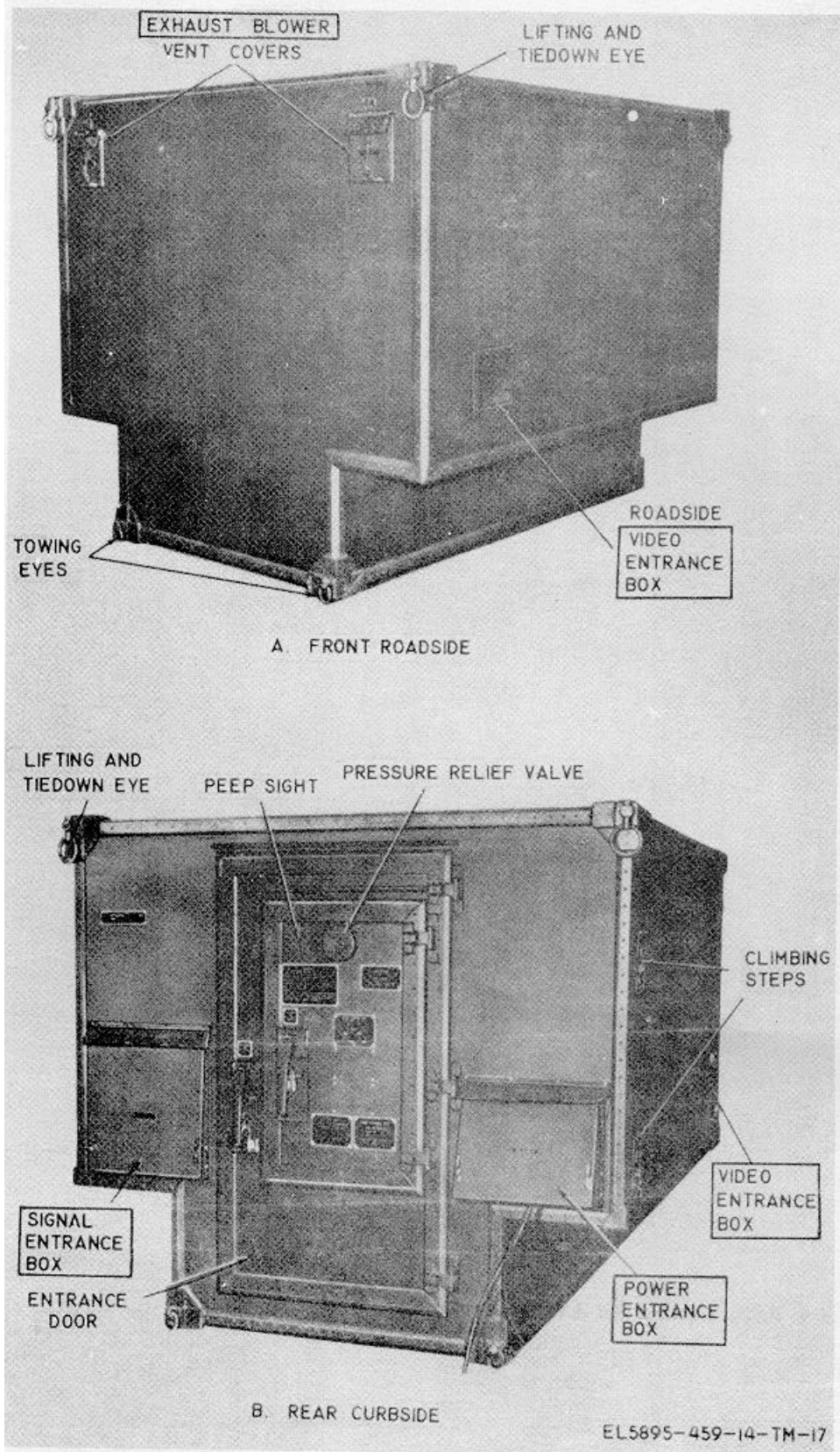

Figure 4-3. Terminal Set, Telephone AN/TCC-69 exterior views.

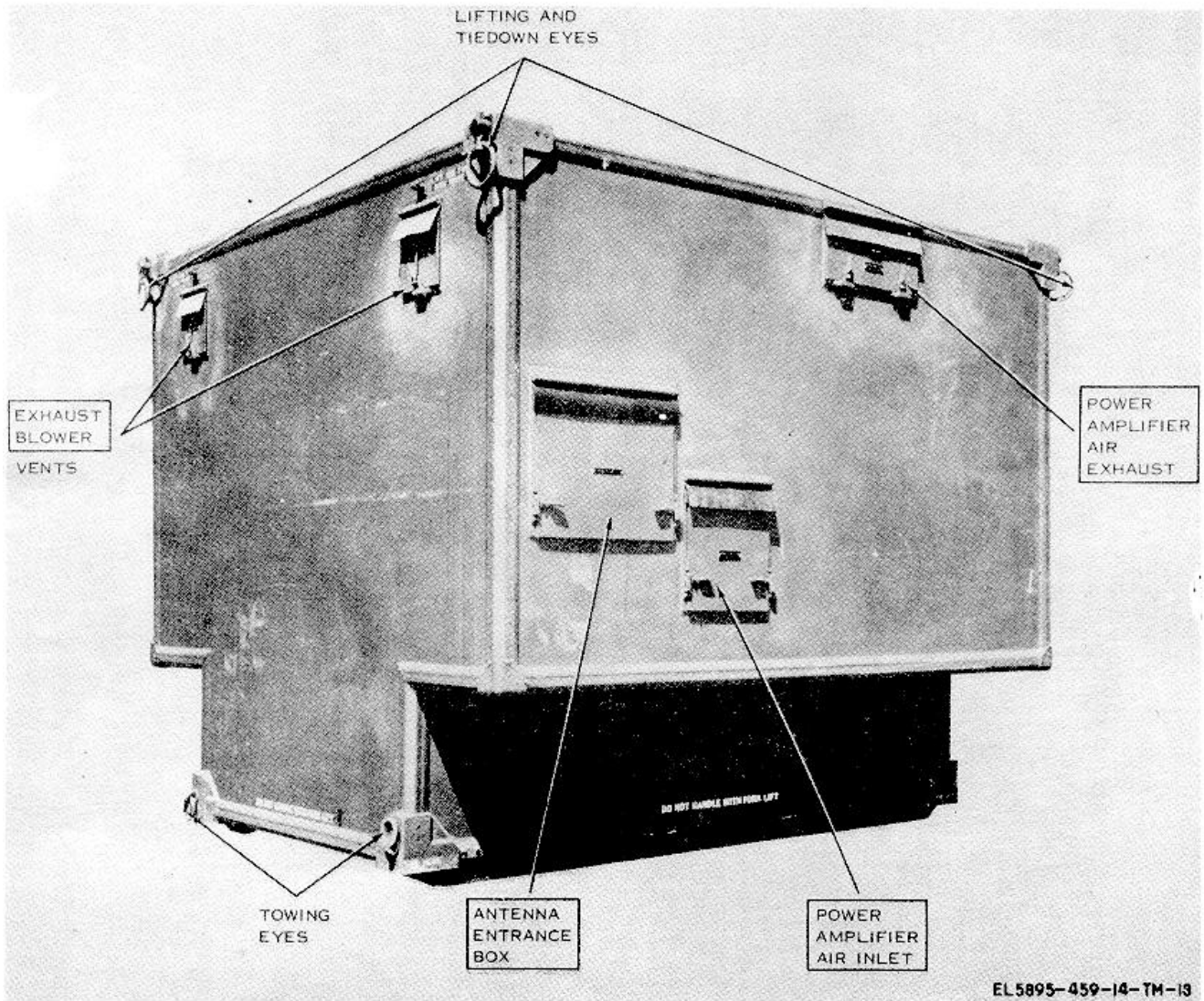

Figure 4-4. Radio Terminal Set AN/TRC-112, front roadside view.

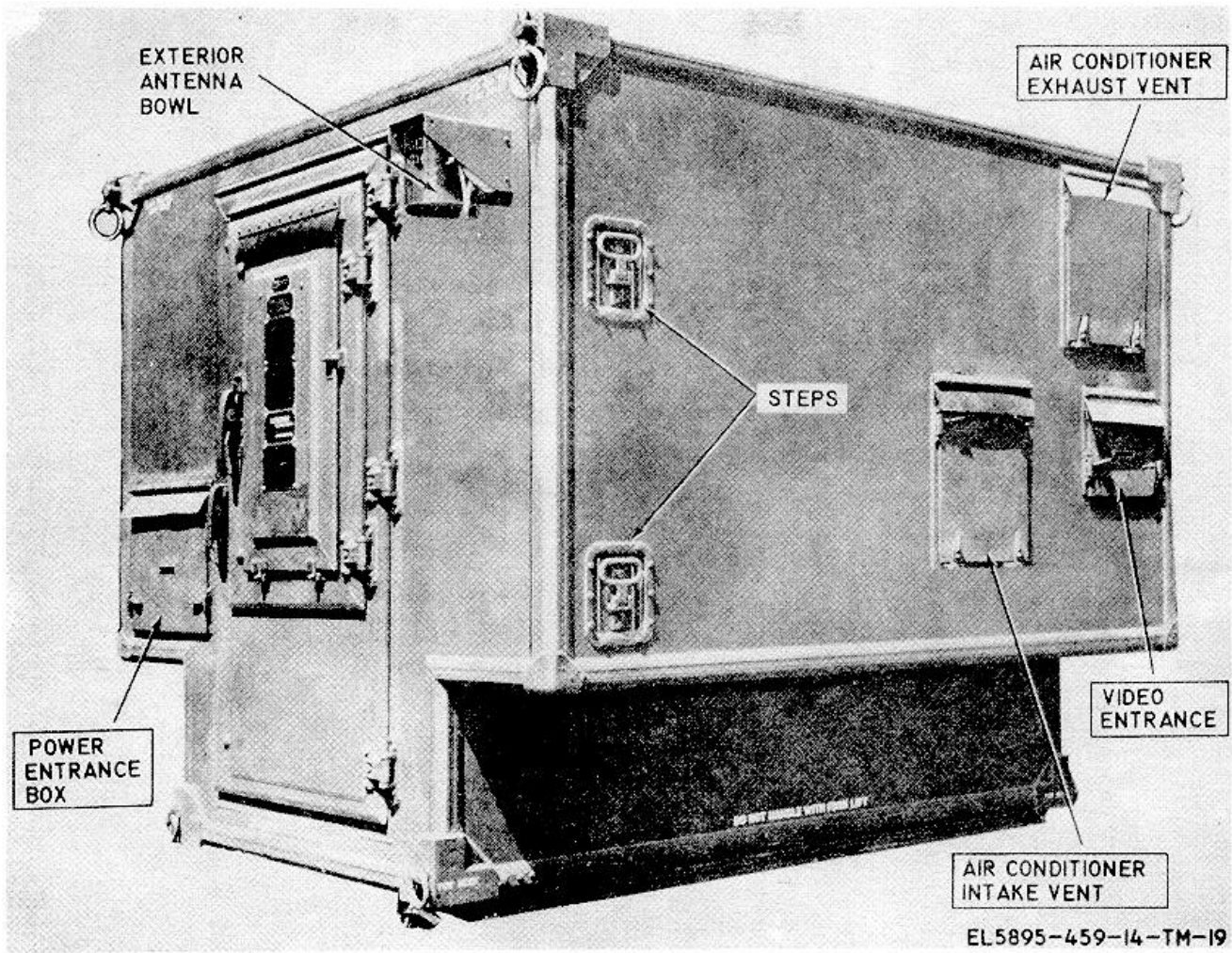

Figure 4-5. Radio Terminal Set AN/TRC-112, rear curbside view.

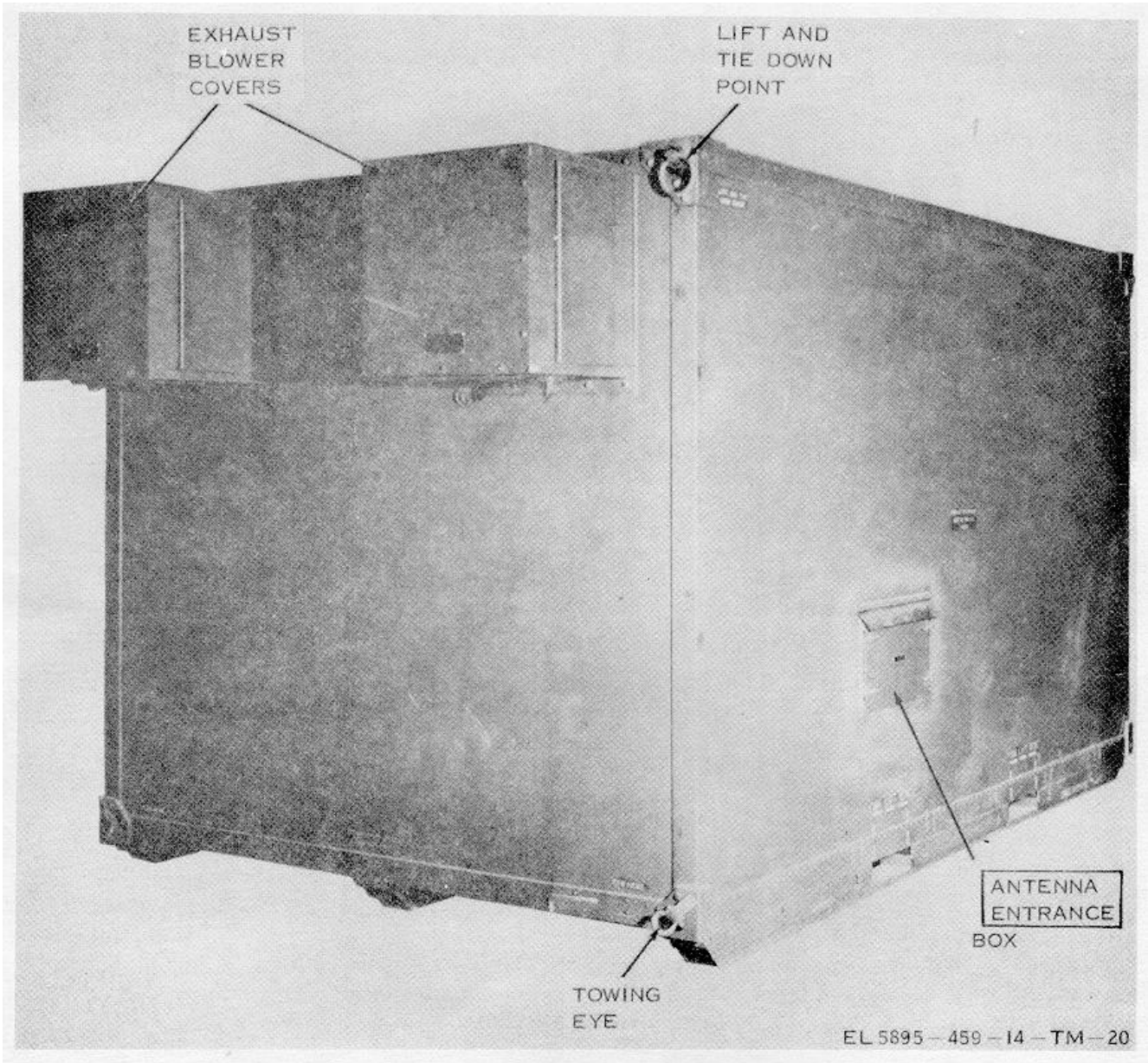

Figure 4-6. Radio Terminal Set AN/TRC-121, front curbside view.

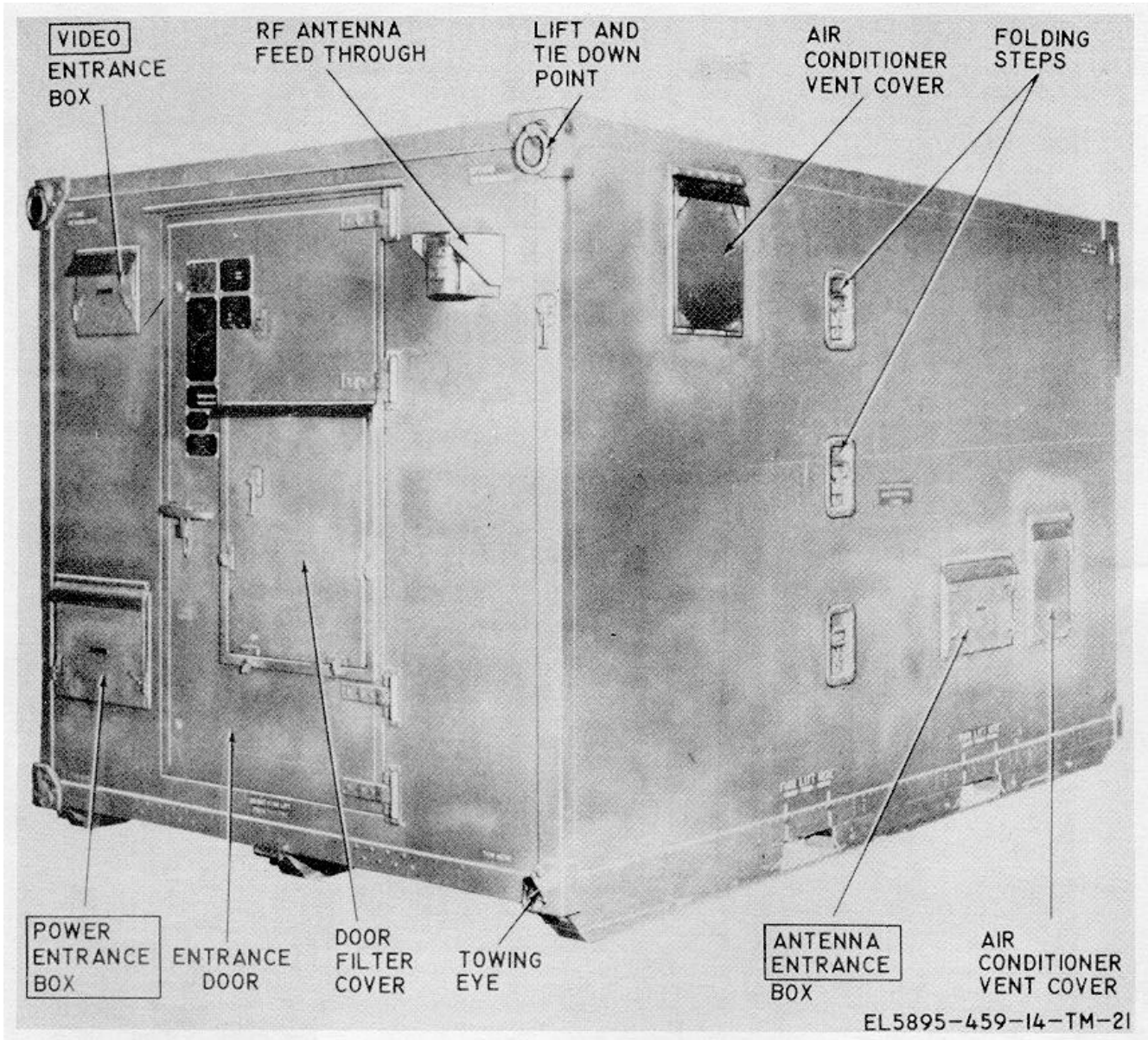

Figure 4-7. Radio Terminal Set AN/TRC-121, rear curbside view.

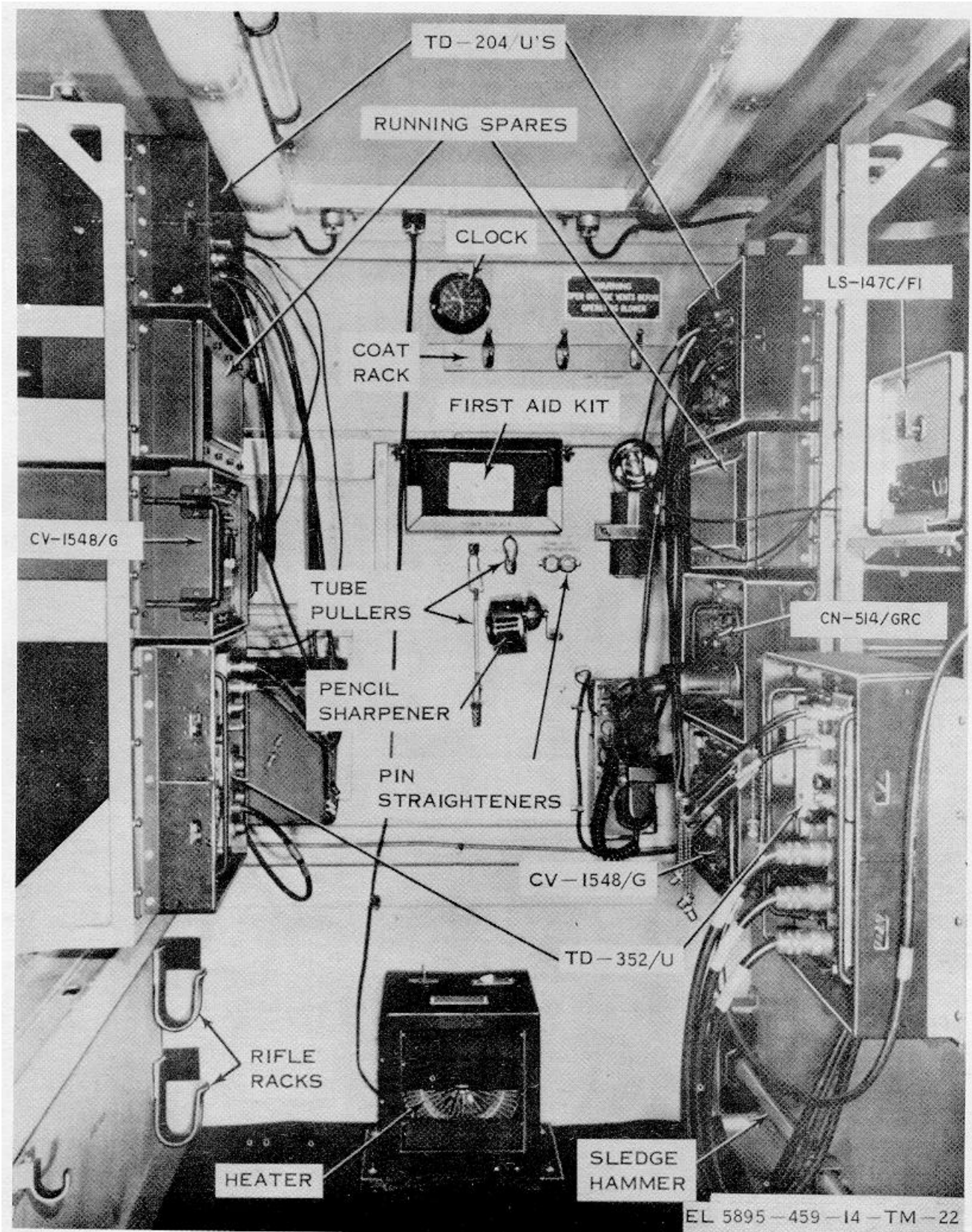

Figure 4-8. Terminal Set, Telephone AN/TCC-60, interior front view.

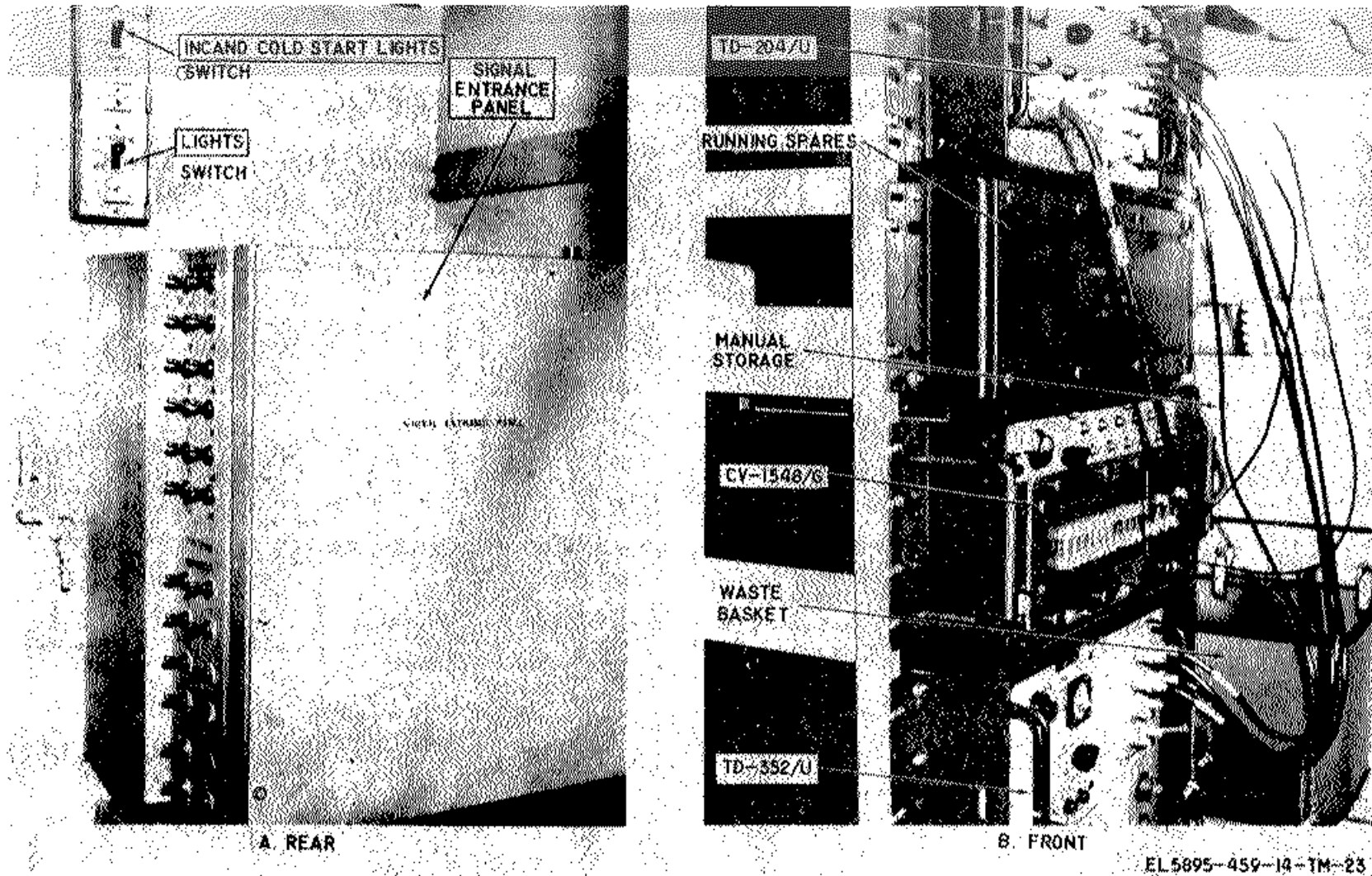

Figure 4-9. Terminal Set, Telephone AN/TCC-60, interior roadside views.

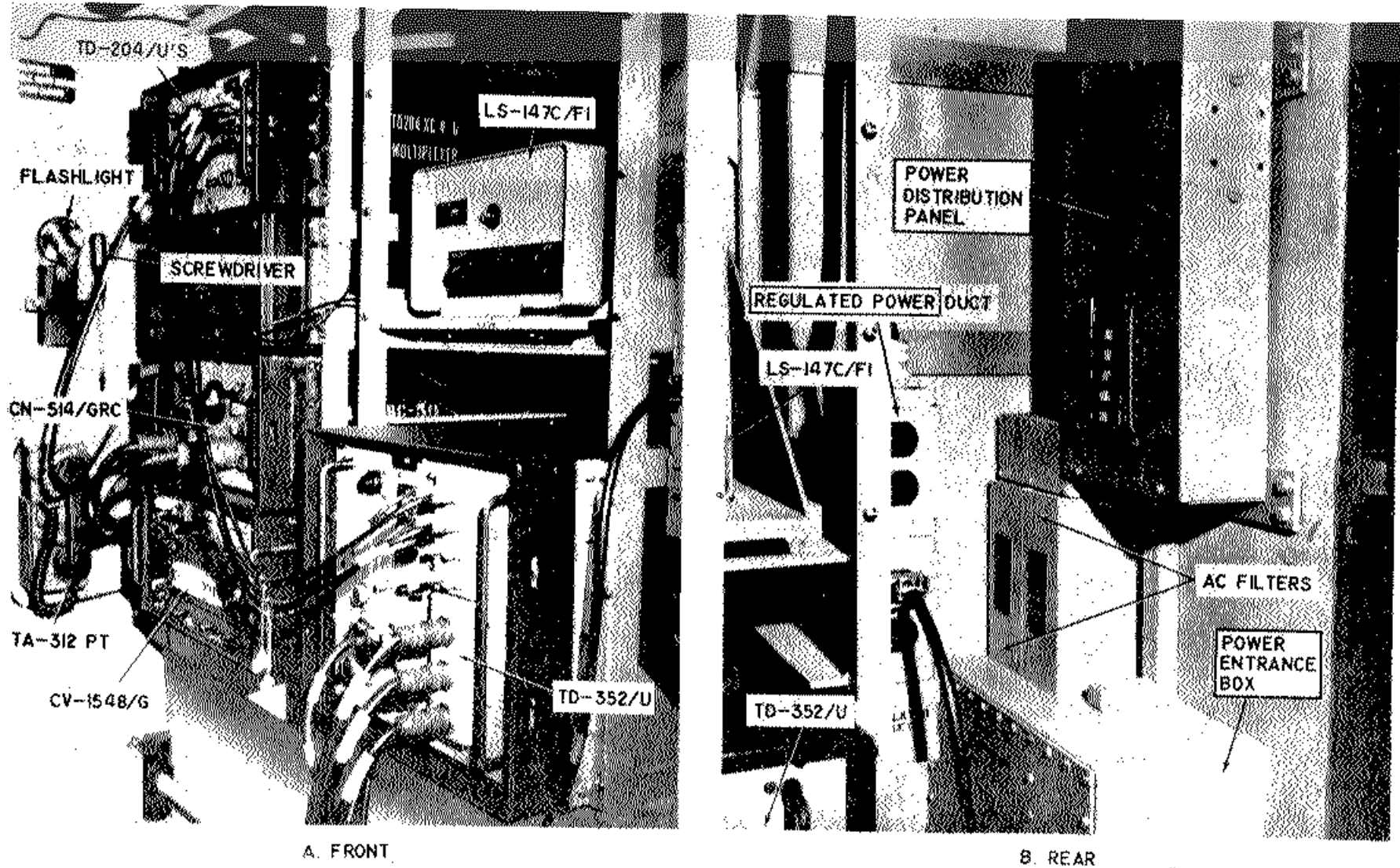

Figure 4-10. Terminal Set, Telephone AN/TCC-60, interior curbside views.

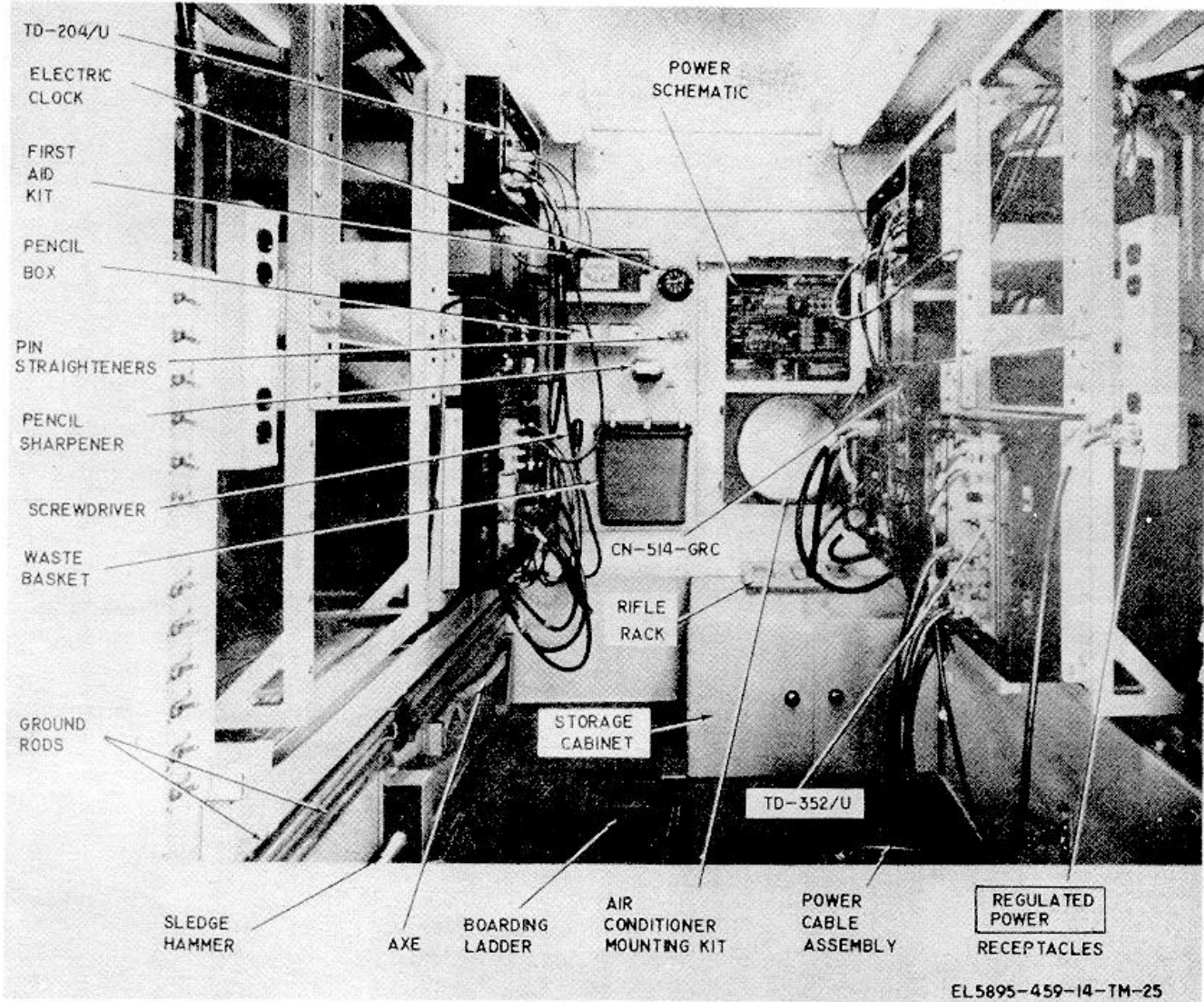

Figure 4-11. Terminal Set, Telephone AN/TCC-69, interior front view.

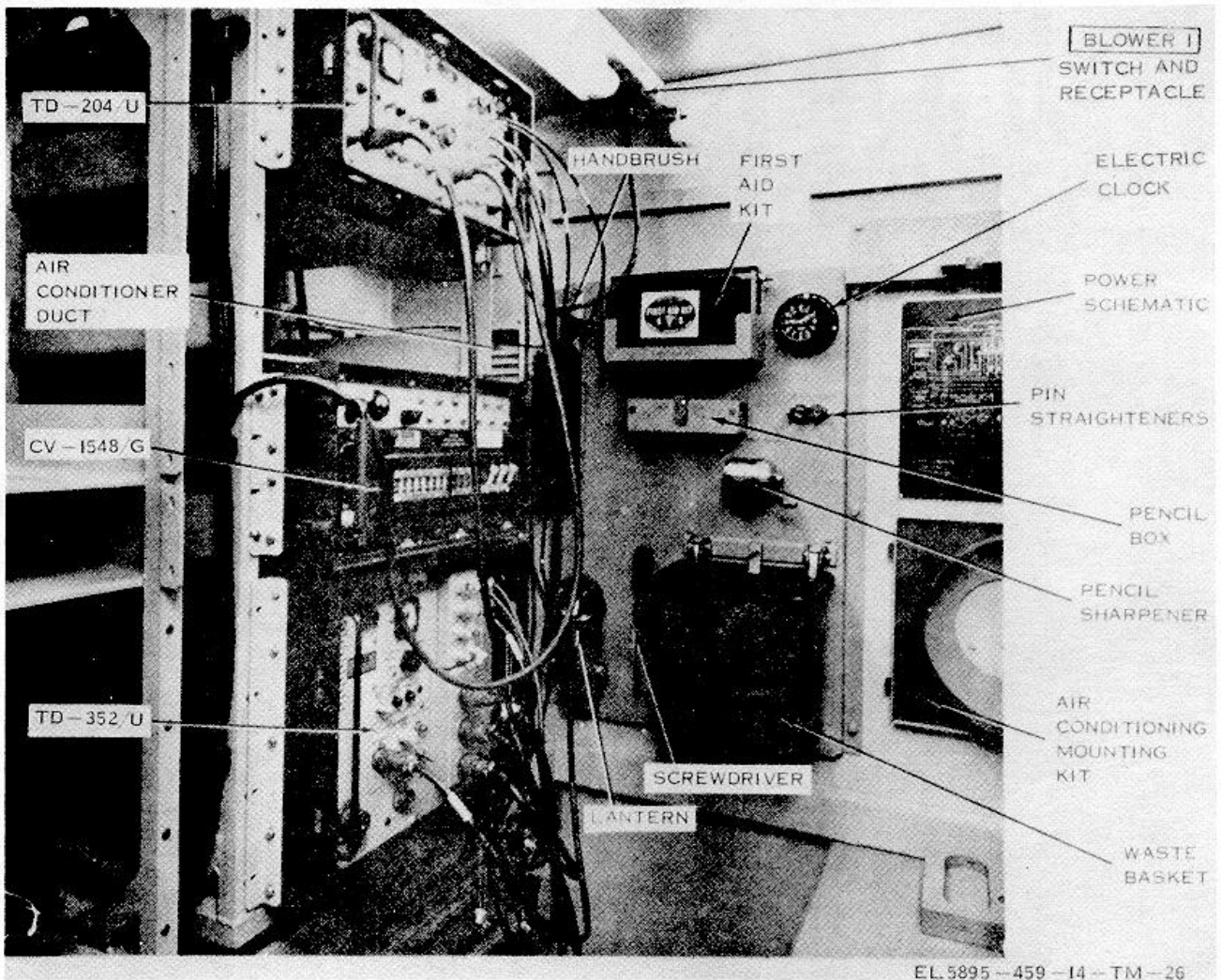

Figure 4-12. Terminal Set, Telephone AN/TCC-69, interior front roadside view.

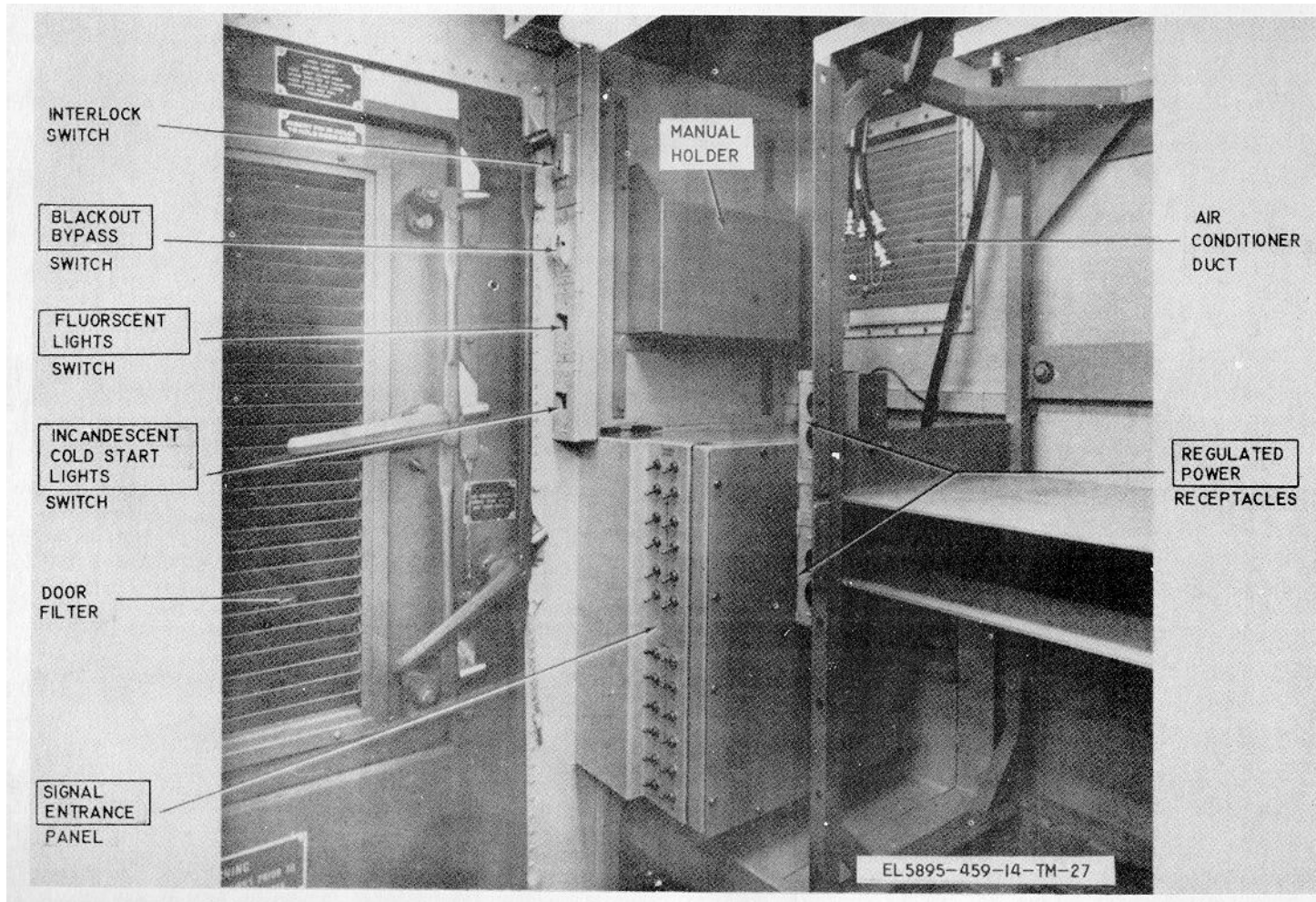

Figure 4-13. Terminal Set, Telephone AN/TCC-69, interior rear roadside view.

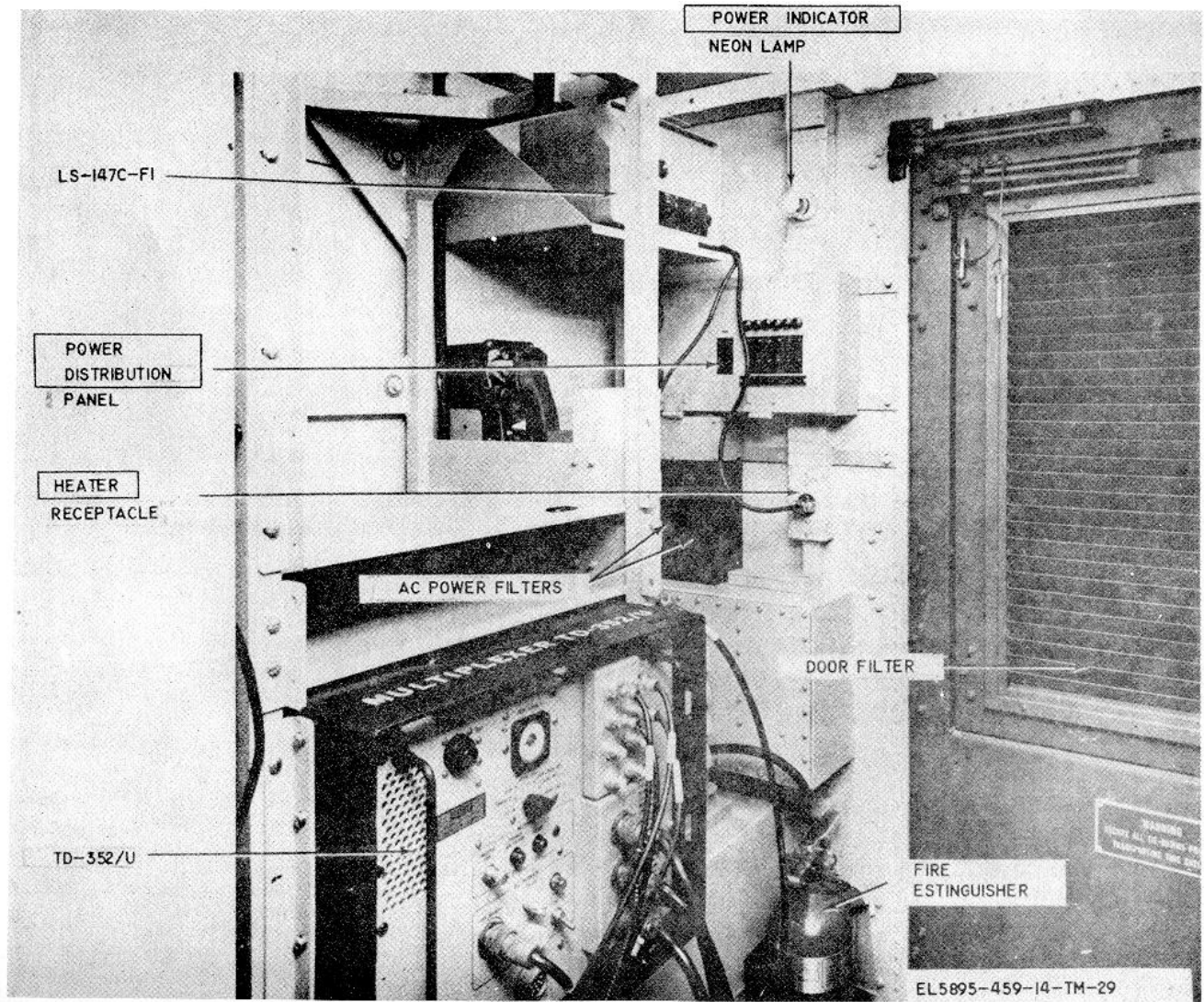

Figure 4-14. Terminal Set, Telephone AN/TCC-69, interior front curbside view.

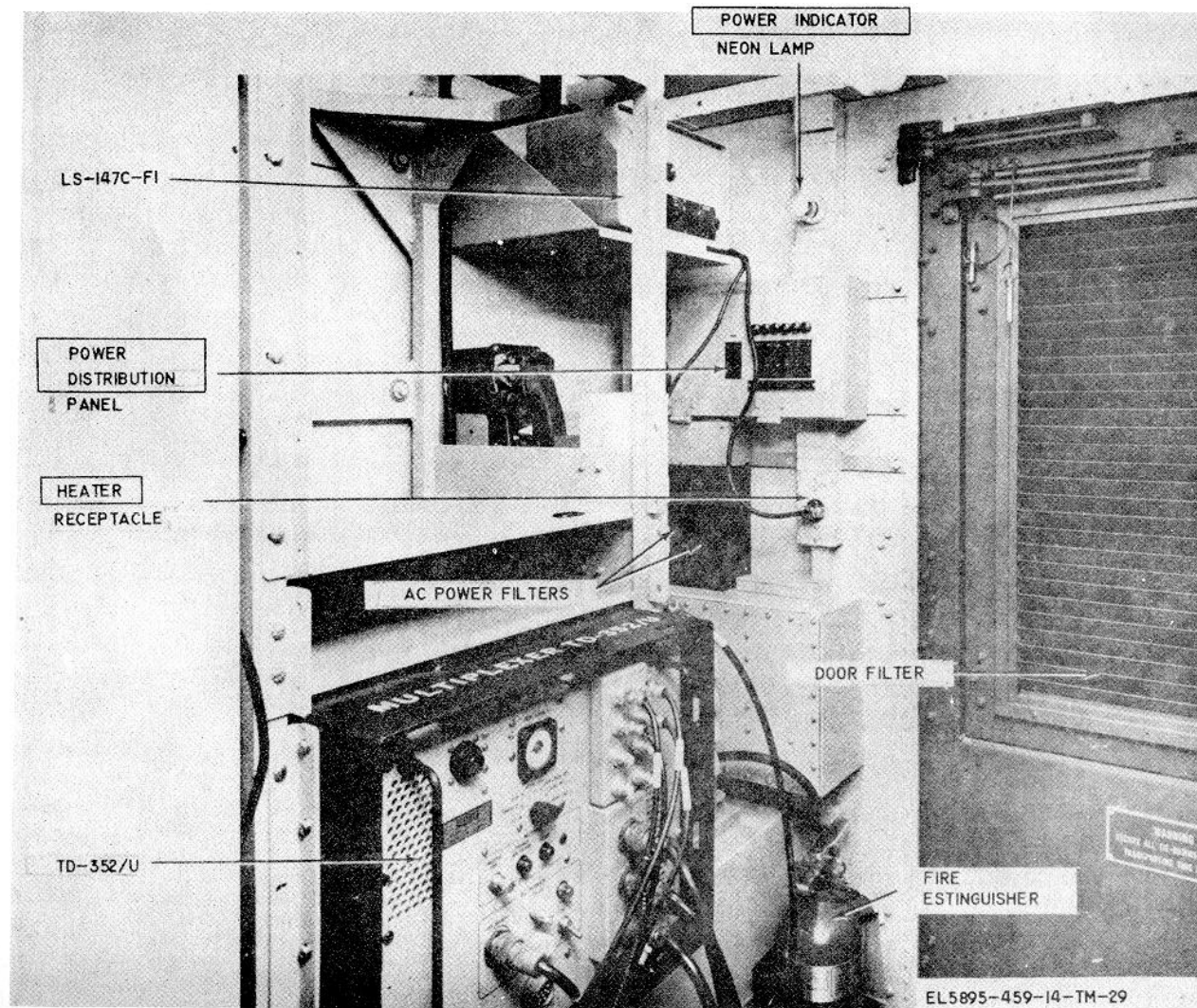

Figure 4-15. Terminal Set, Telephone AN/TCC-69, interior rear curbside view.
4-17

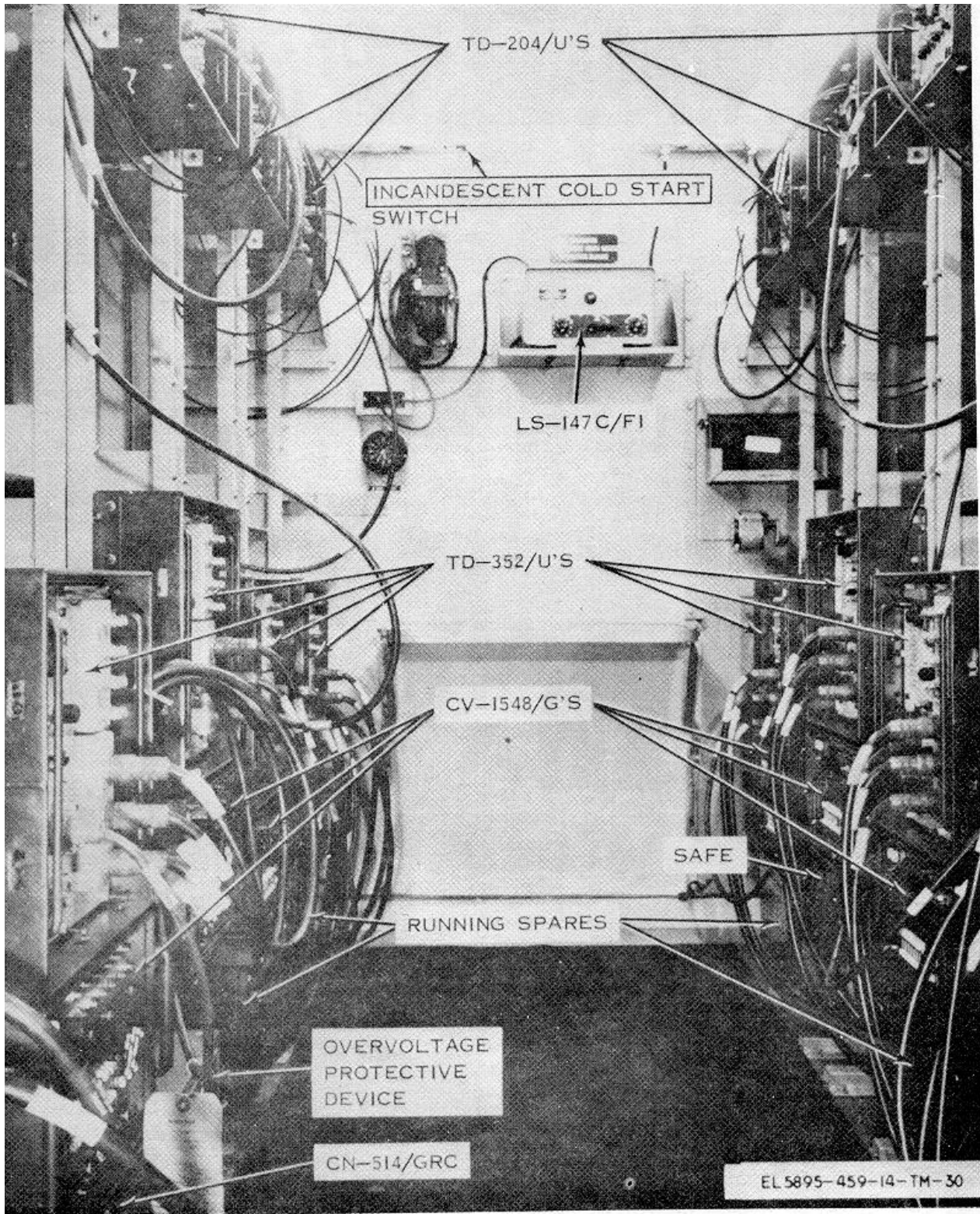

Figure 4-16. Terminal Set, Telephone AN/TCC-61, interior front view, less TSEC/KG-27's.

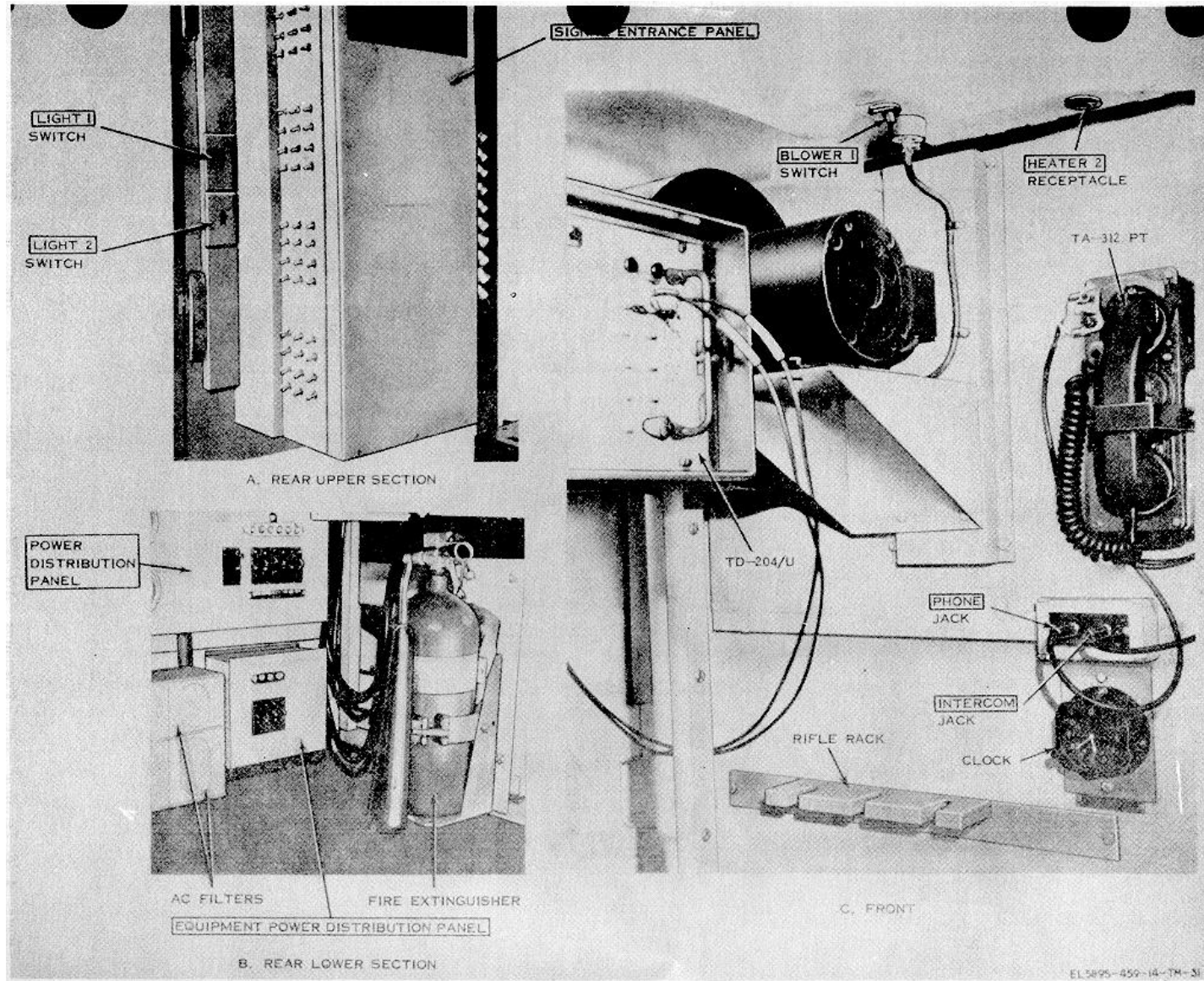

Figure 4-17. Terminal Set, Telephone AN/TCC-61, interior roadside views, less TSEC/KG-27's
4-19

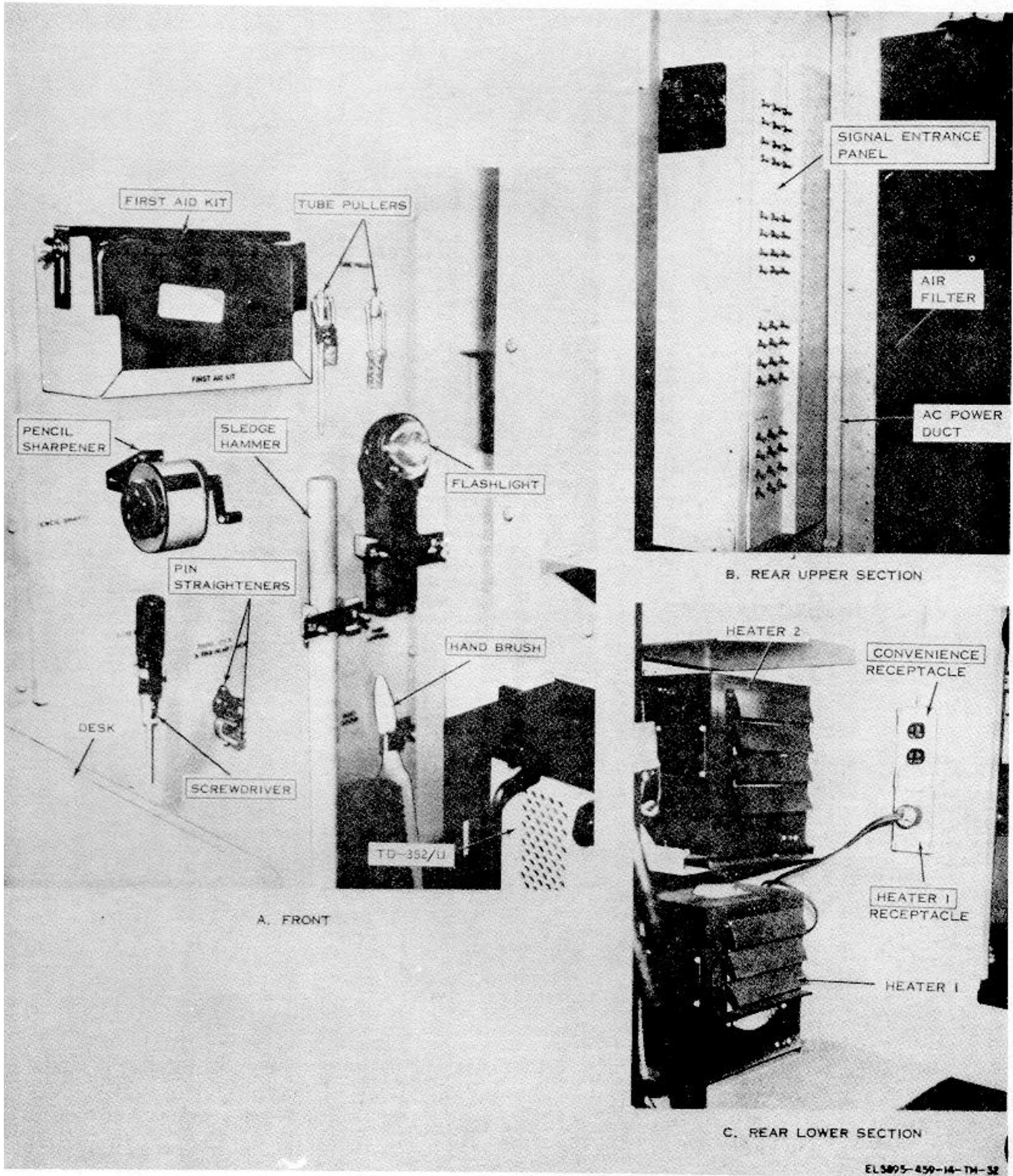

Figure 4-18. Terminal Set, Telephone AN/TCC-61, interior curbside views, less TSEC/KG-27's.

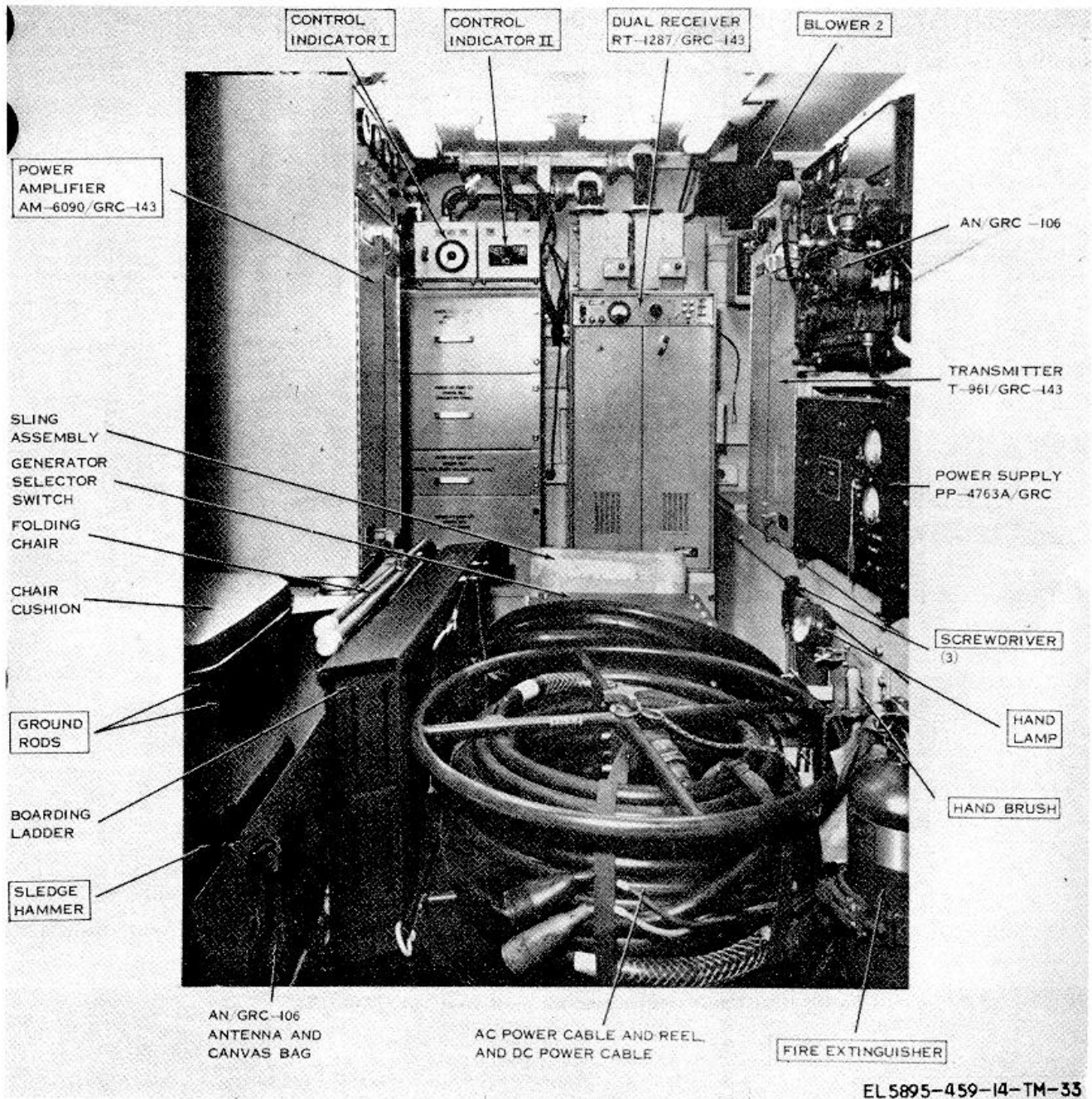

Figure 4-19. Radio Terminal Set AN/TRC-112, interior front view.

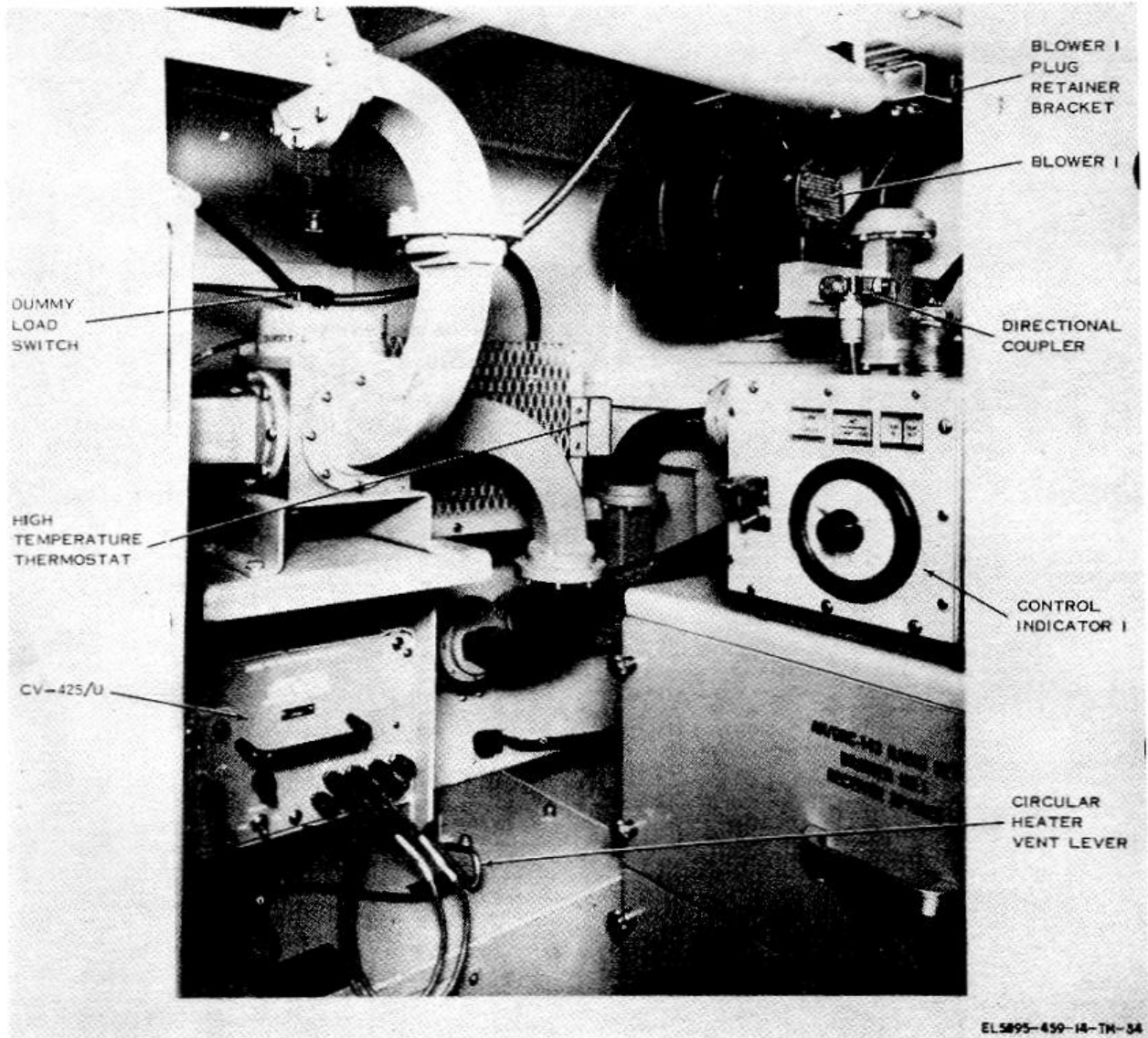

Figure 4-20. Upper interior roadside front view, AN/TRC-112.

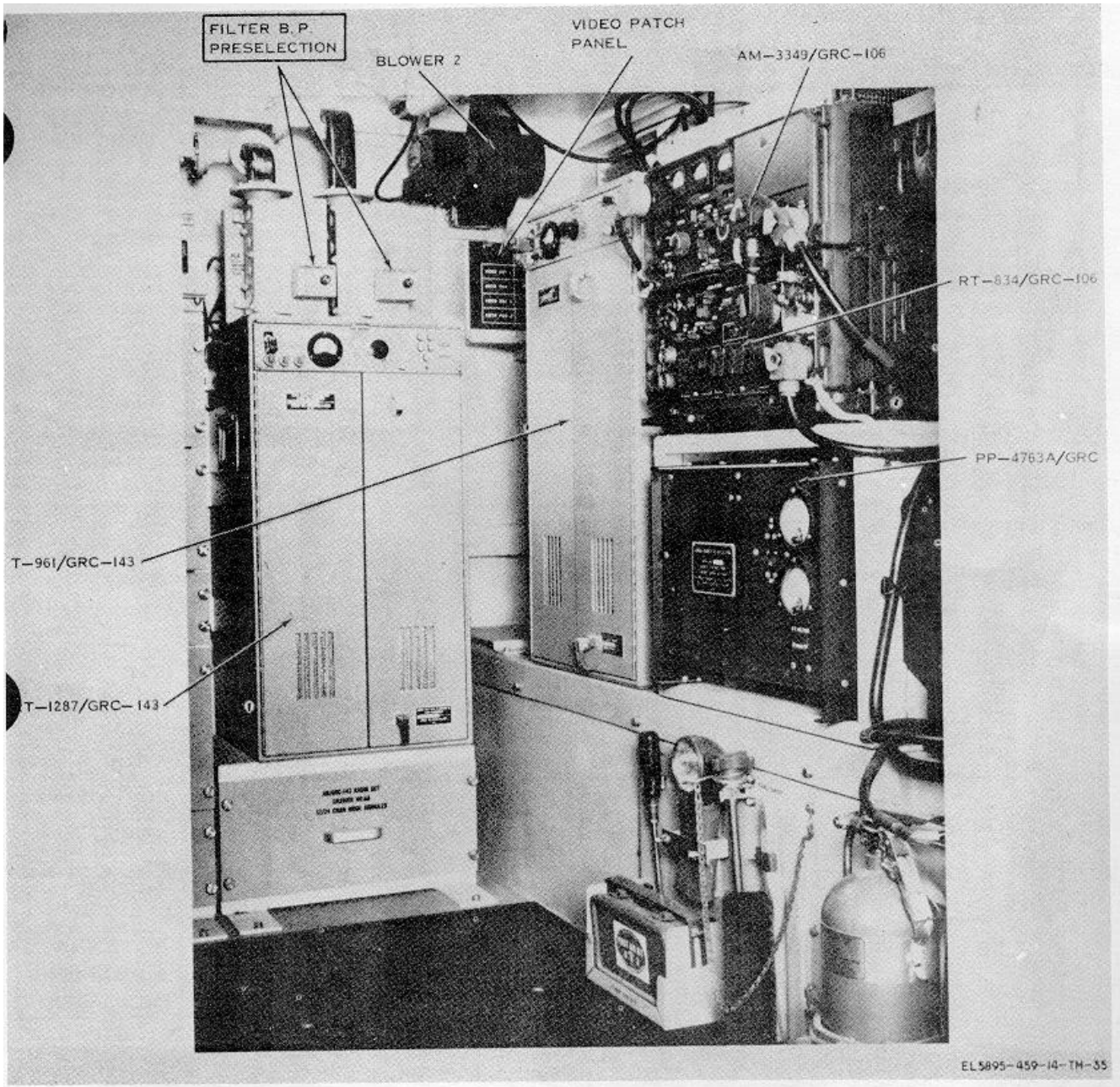

Figure 4-21. Radio Terminal Set AN/TRC-112, interior front curbside view.

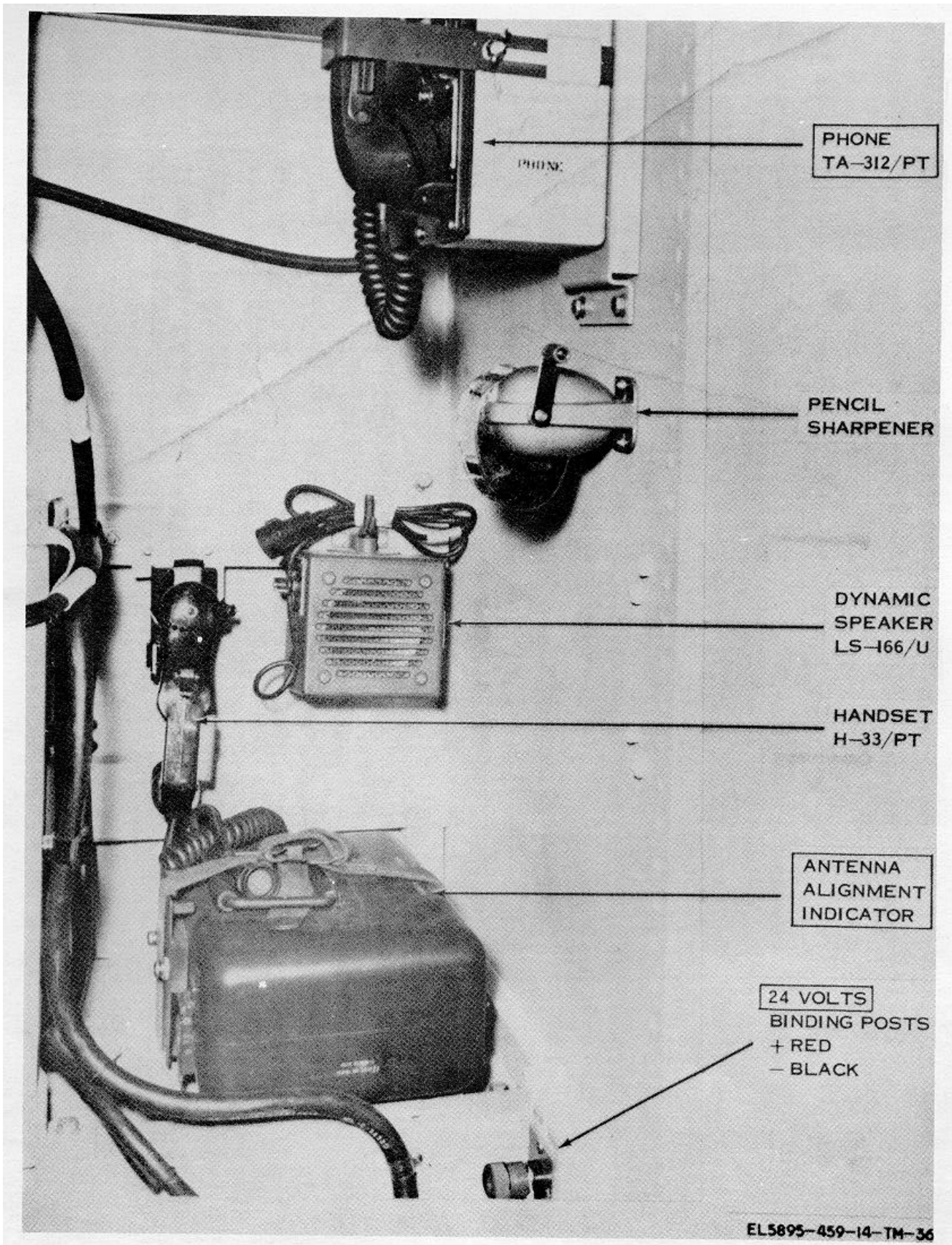

Figure 4-22. Interior curbside front wall, AN/TRC-112.

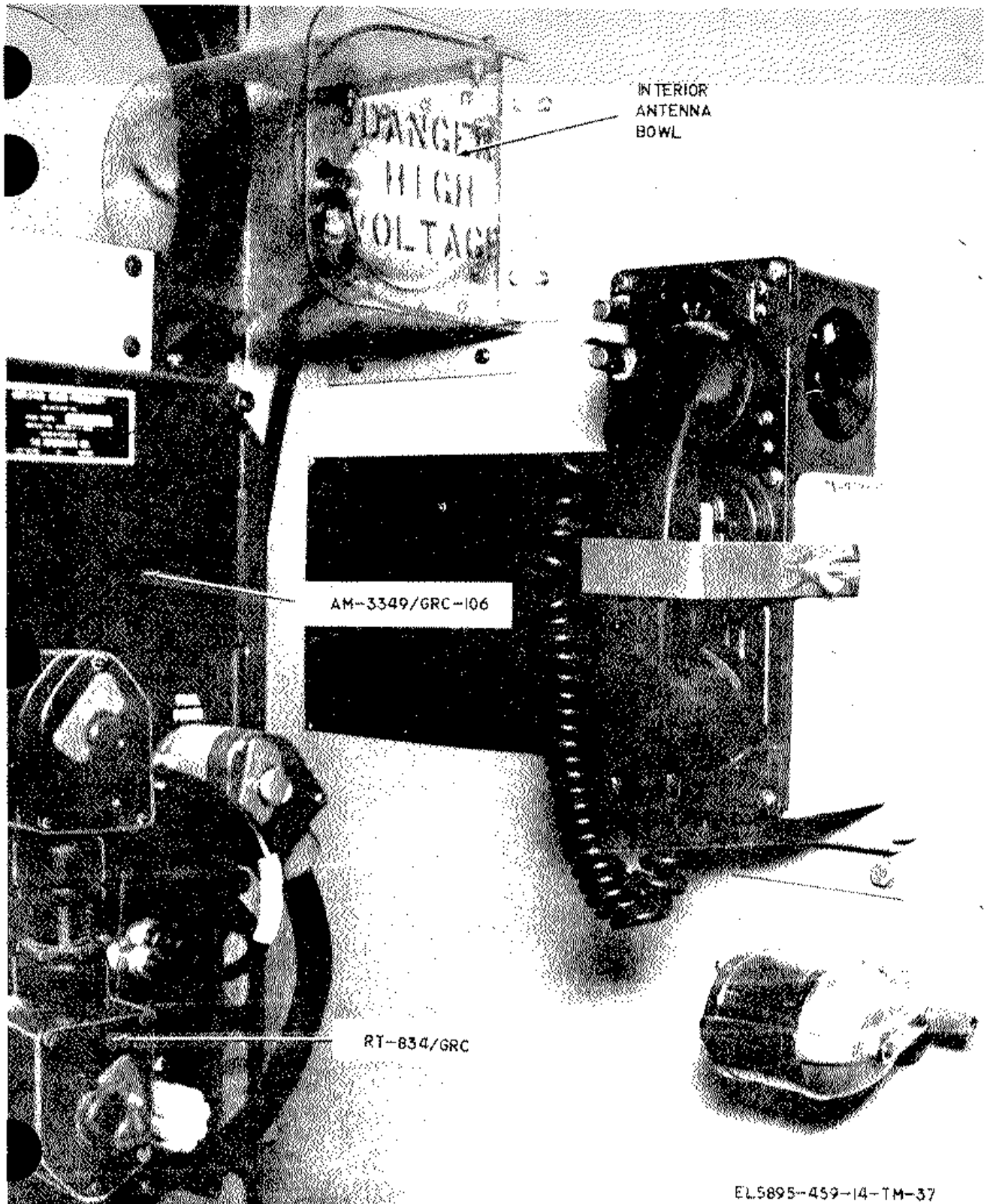

Figure 4-23. Radio Terminal Set AN/TRC-112, interior upper rear curbside view .

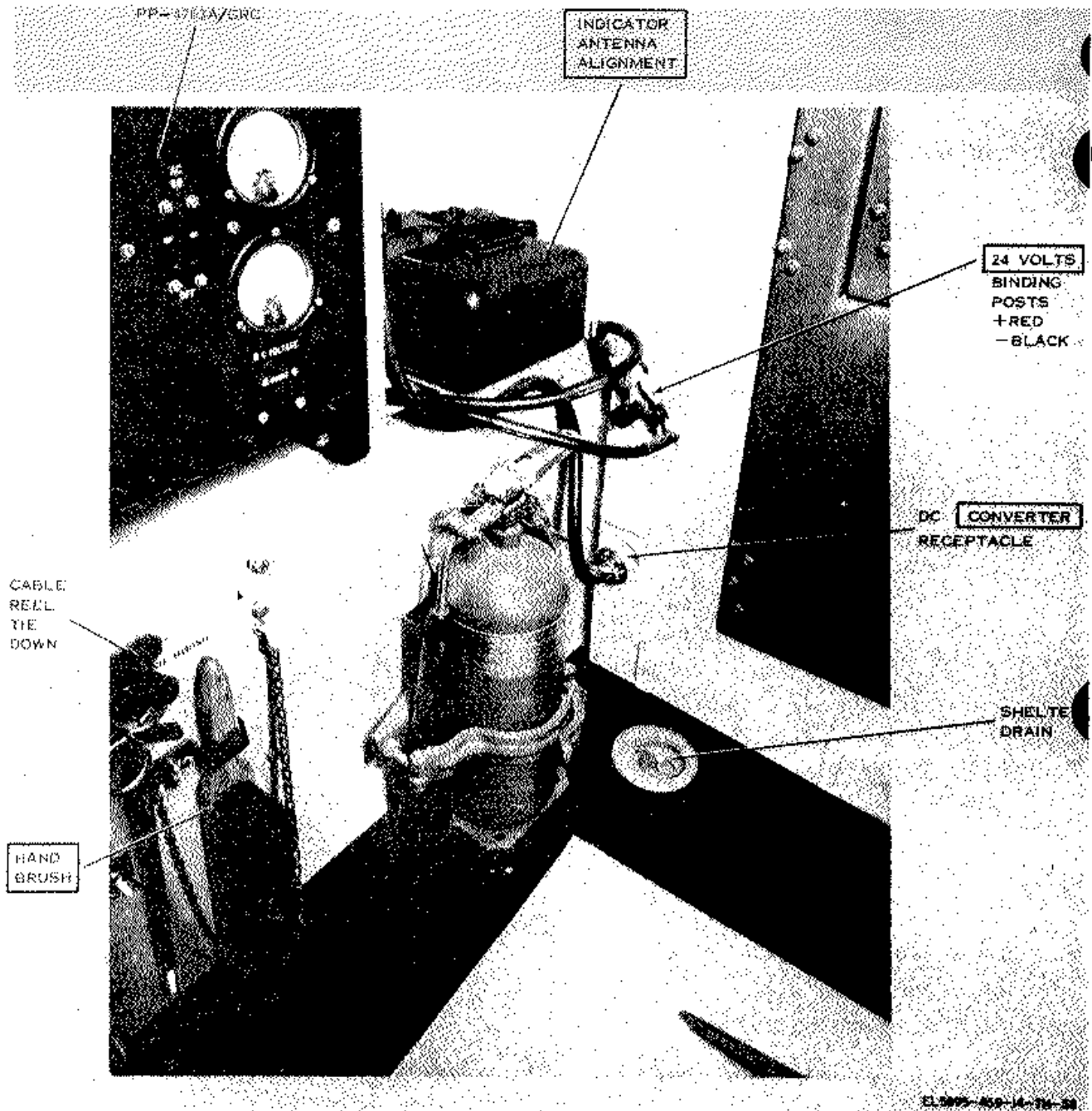

Figure 4-24. Radio Terminal Set AN/TRC-112, interior lower rear curbside view .

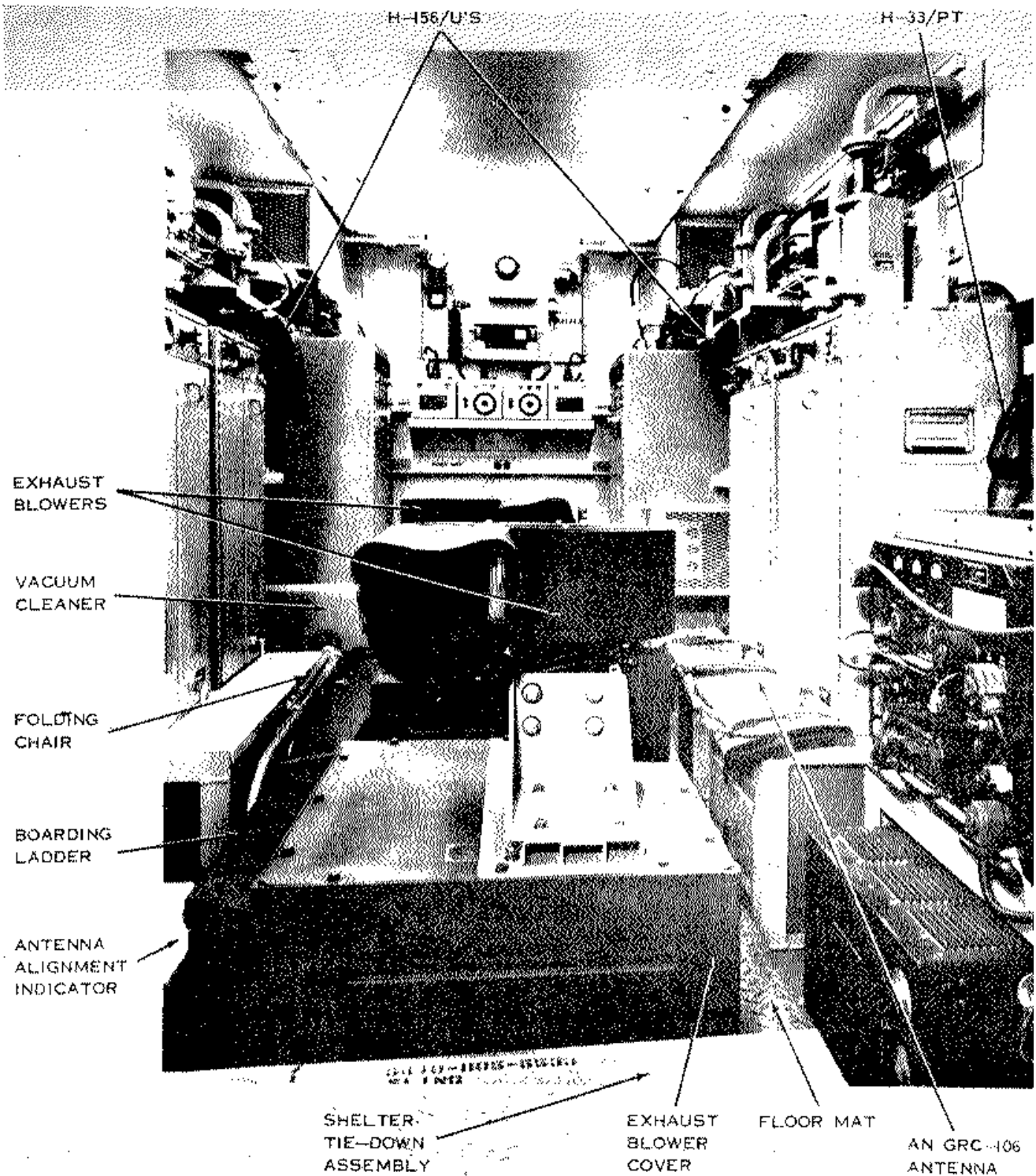

Figure 4-25. Radio Terminal Set AN/TRC-112, interior front view, packaged for shipment.

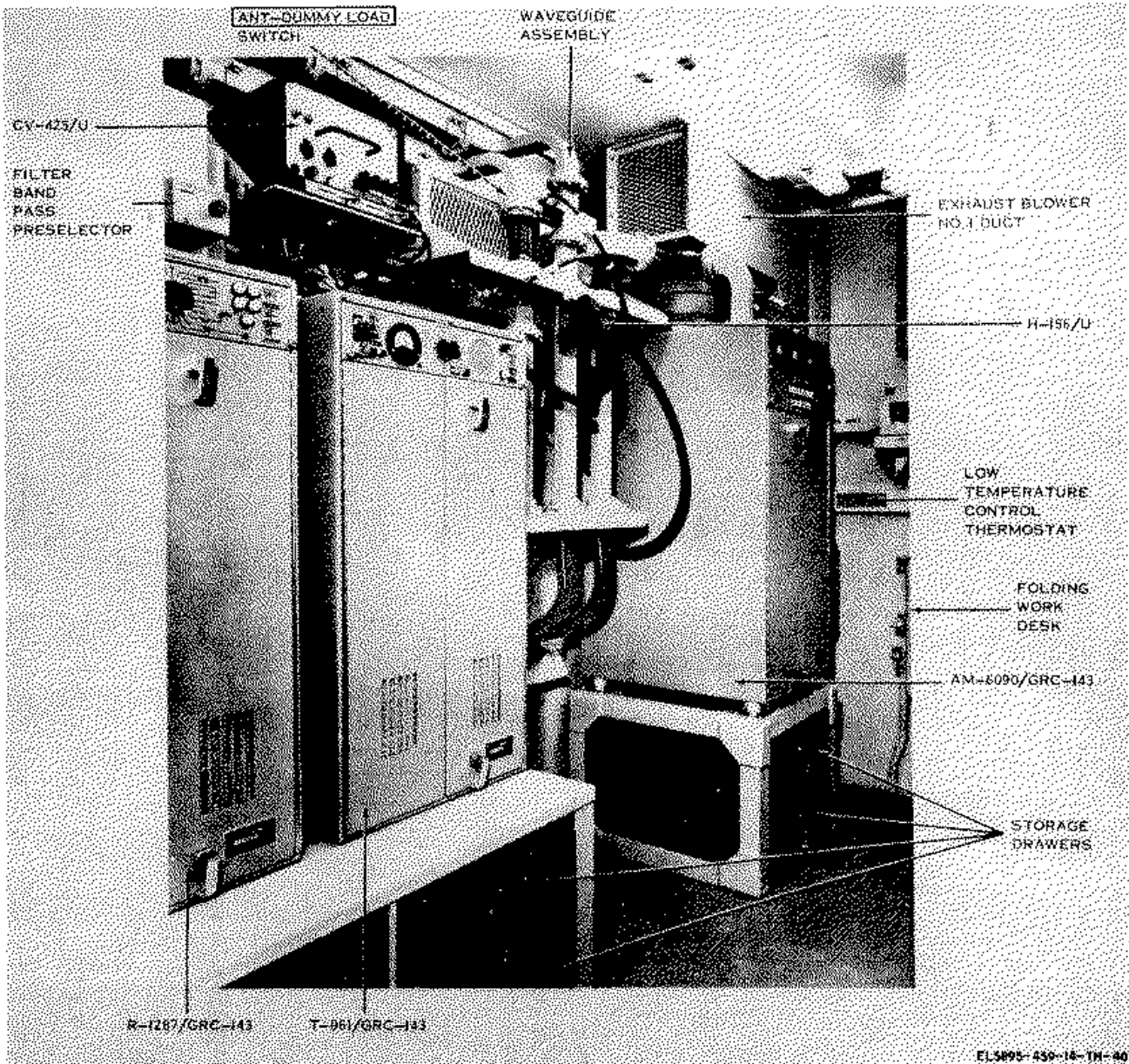
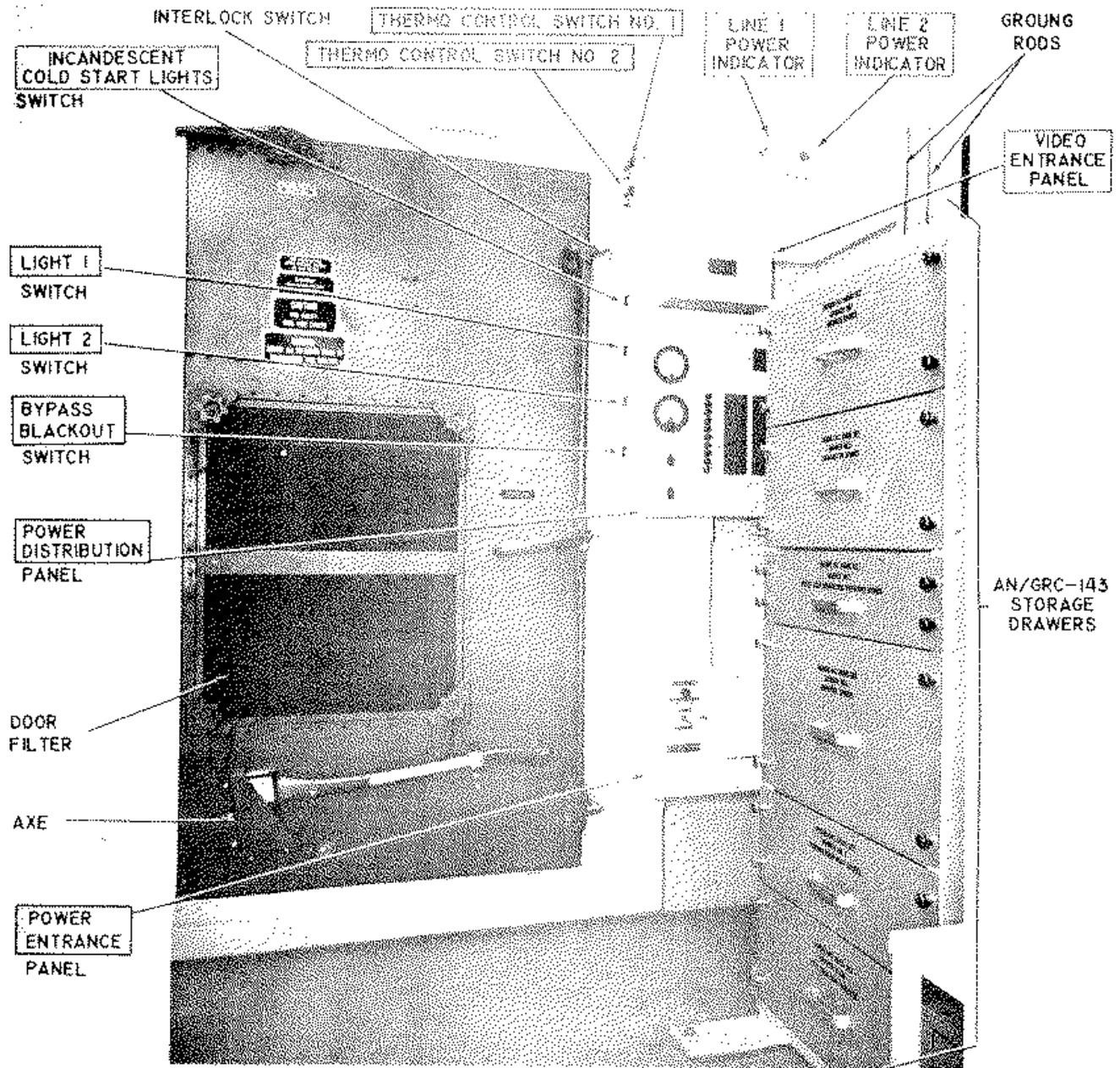

Figure 4-26. Radio Terminal Set AN/TRC-121, interior front roadside view.



EL 5895-459-14-TM-41

Figure 4-27. Radio Terminal Set AN/TRC-121, interior rear roadside view.

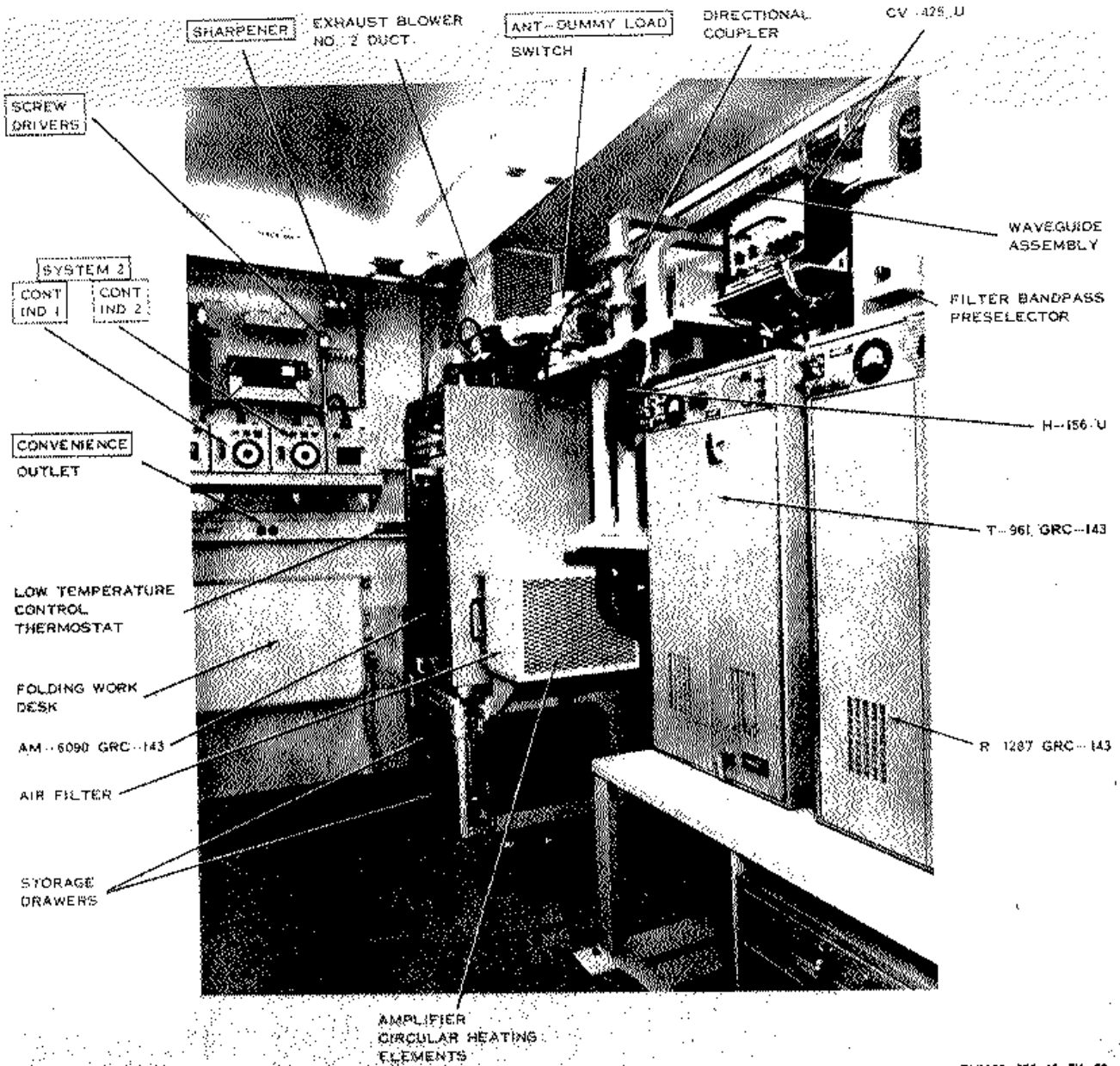

Figure 4-28. Radio Terminal Set AN/TRC-121, front curbside view.

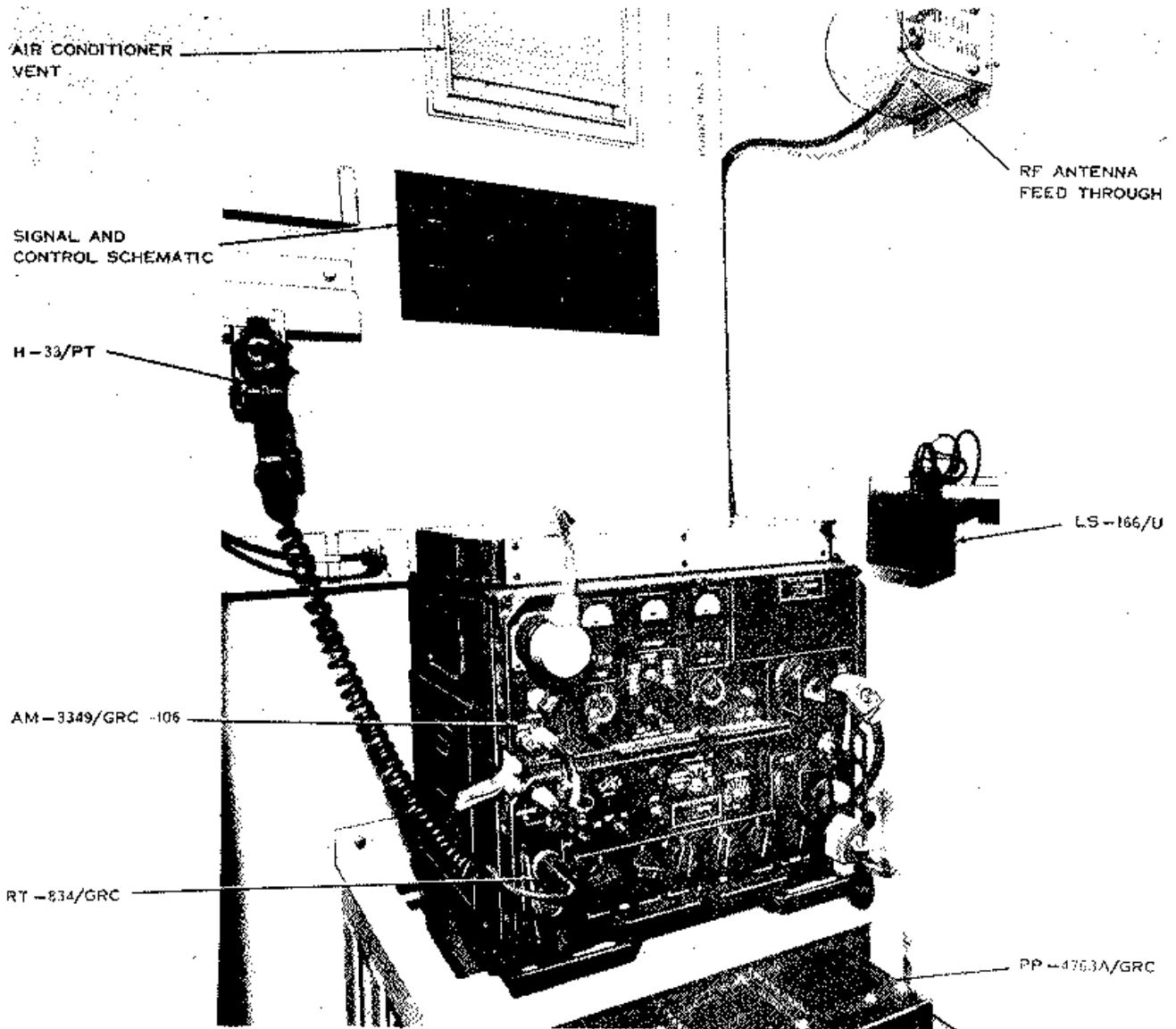

Figure 4-29. Radio Terminal Set AN/TRC-121, rear curbside view.

CHAPTER 5

ASSEMBLAGE CAPABILITIES

5-1. General

The components of the Tropospheric Scatter Tactical Radio Relay System can be configured to meet Army and Command Corps communication requirements. A block diagram of a typical two station, tropospheric scatter communications link is shown in figure 5-1. Each assemblage in the system contains specified quantities of components (table 6-1) to allow maximum versatility and satisfy definite requirements for any practicable 24-channel tropospheric system. The capabilities of each assemblage are indicated in paragraph 5-2 through 5-5.

5-2. Terminal Sets, Telephone AN/TCC-60 and AN/TCC-69

The two equipment sets of the AN/TCC-60/69 can be arranged to provide one 24-channel cable terminal facility supplementing radio terminal facilities in a tropospheric system as shown in figure 5-2.

5-3. Terminal Set, Telephone AN/TCC-61

The, eight equipment sets of the AN /TCC-61 can be arranged to provide four 24-channel cable terminal facilities supplementing radio terminal facilities in a tropospheric system as shown in figure 5-2.

5-4. Radio Terminal Set AN/TRC-112

Radio Terminal Set AN/TRC-112, basically consisting of Radio Sets AN/GRC-143 and AN/QRC-106A, can provide tactical tropospheric communications over distances up to 100 miles, with teletypewriter communications up to 200 miles. It can transmit up to 24 voice channels, data, or teletypewriter signals in conjunction with standard military multiplex equipment.

5-5. Radio Terminal Set AN/TRC-121

Radio Terminal Set AN/TRC-121 employs two equipment sets which can provide split terminal facilities in a tropospheric scatter system. Basically consisting of Radio Set AN/GRC-143 and AN/GRC-106A, it has a traffic capacity of 24 channels in configuration with standard military multiplex equipment.

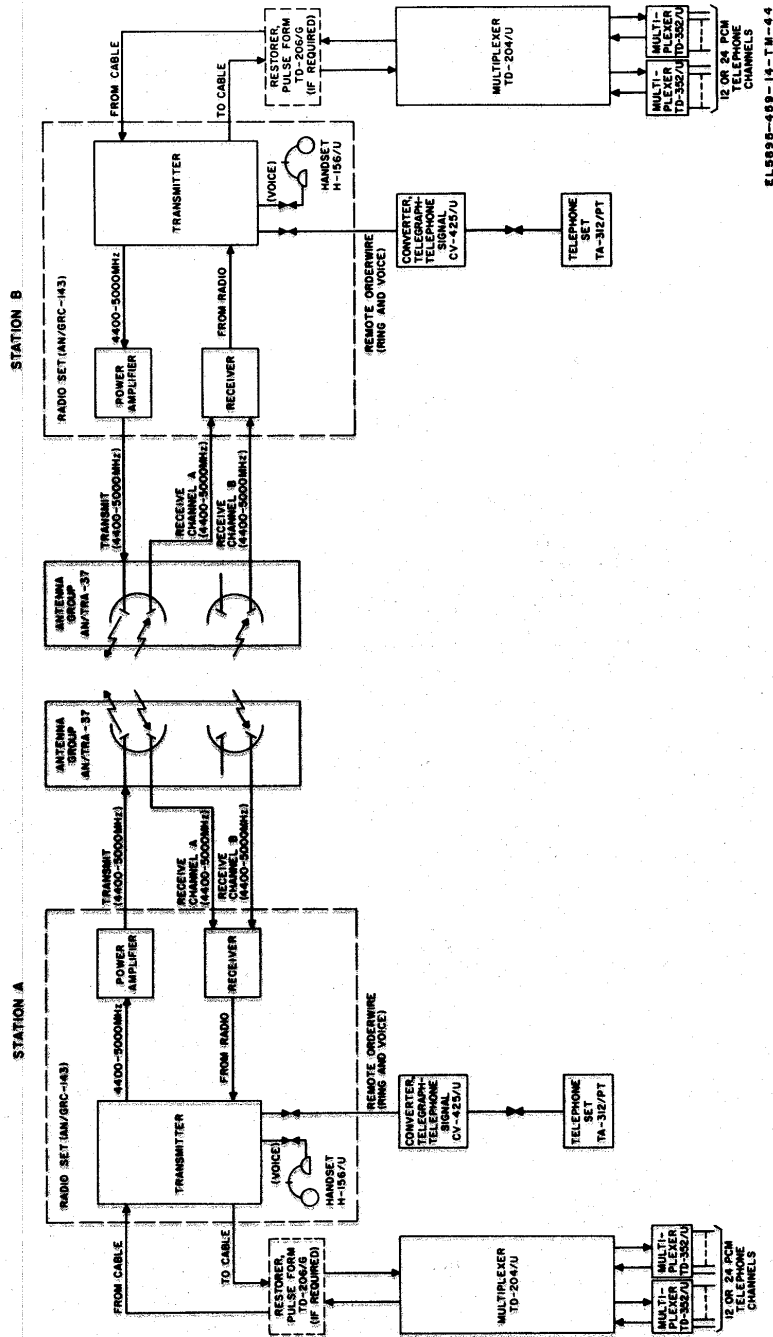
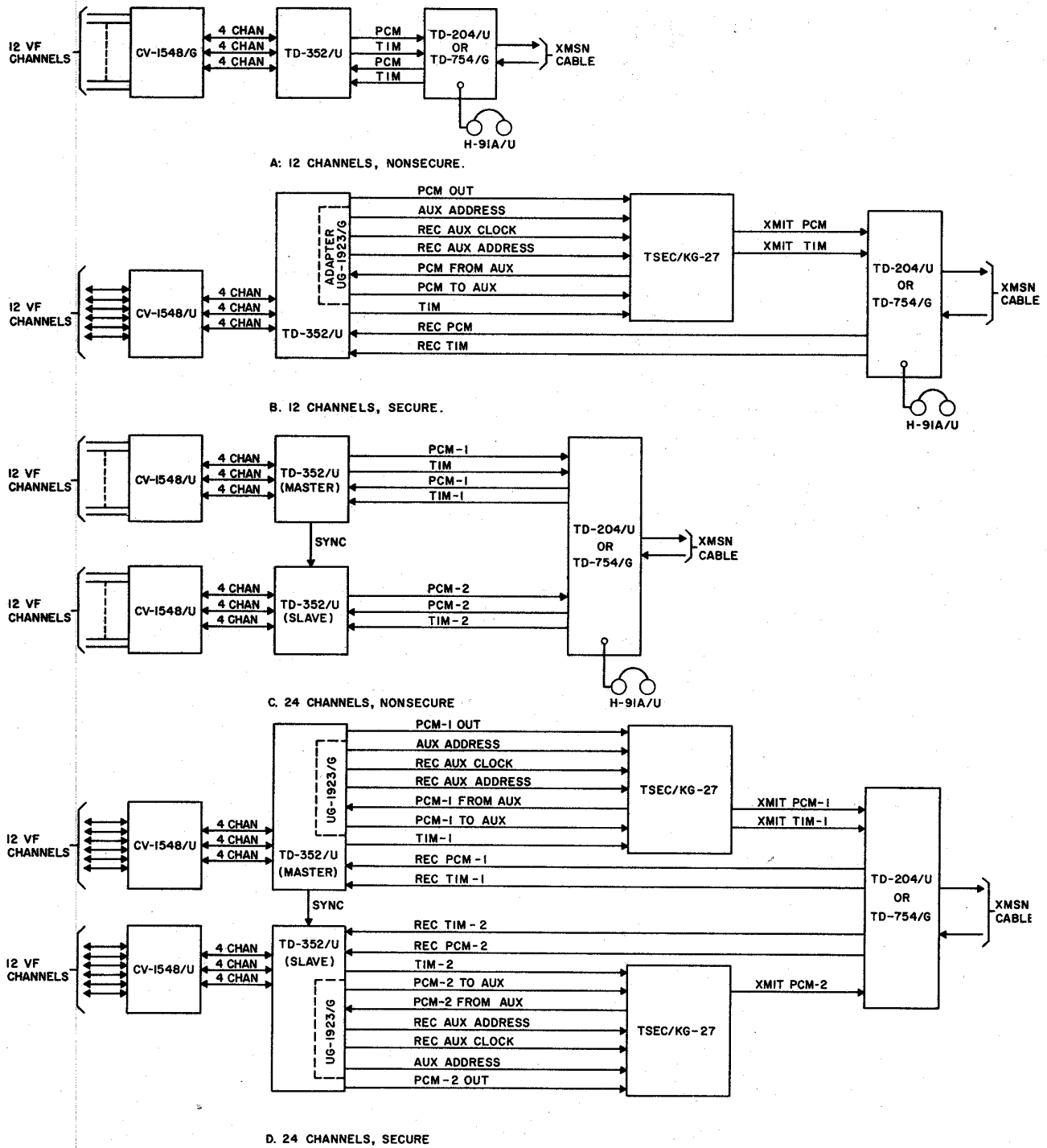

Figure 5-1. Typical two station, tropospheric scatter, communications link.



EL 5895-459-14-TM-45

Figure 5-2. Component arrangements for 12- and 24-channel cable terminal facilities, block diagram.

**CHAPTER 6
SYSTEM DESCRIPTION AND ENGINEERING**

SECTION I. DESCRIPTION AND DATA

6-1. Purpose and Use

a. Purpose. The Tropospheric Scatter Tactical Radio Relay System provides compatible circuitry for the 24-channel transmission of voice, data, or telegraph signals. The signal range can be up to 200 miles, depending upon type of transmission.

b. Use. The Tropospheric Scatter Tactical Radio Relay System is primarily used to connect adjacent Corps and Commands. It may also be used between Corps and TASCOC (fig. 6-1).

6-2. System Assemblages

Table 6-1 lists the assemblages, major components and their primary employment, within the Army Tactical Communications System (ATACS). The quantities of the listed major components are to allow for, and satisfy, the requirements of a 24-channel tropospheric system.

6-3. Capabilities and Limitations

Transmission medium Single two-way radio and cable

Cable transmission:

 Maximum length 240 miles

 Unattended repeater

 (TD-206/G) 1-, 1/4-, 1/2-, or 3/4 mile intervals

Radio transmission:

Frequency 4,400 to 5,000 MHz

Range Up to 200 miles with teletypewriter communications

SECTION II. SYSTEMS ENGINEERING

6-4. General

a. Scope. The information in this section covers communications planning and antenna siting procedures for the purpose of planning and siting a tropospheric scatter radio system. The tropospheric scatter system permits communication between sites when a direct line-of-sight path between antennas is obstructed by hilly or mountainous terrain or by the curvature of the earth.

b. Basic Principles of Tropospheric Scatter Propagation. The radio site transmitting antenna radiates a narrow beam of microwave energy directed toward the horizon, through the troposphere. The troposphere is that portion of the earth to heights of about 11 kilometers (approximately 6.8 miles). The narrow viewing angle, antenna beam width, of the receiving antenna is also directed toward the horizon. Communication is effected by means of the common scatter volume in the troposphere as seen by both antennas. This volume is formed by the intersecting transmit and receive antenna beam paths. The transmit antenna transmits energy into this common volume and the receiving antenna derives energy from it.

6-5. Requirements for Communications Planning and Antenna Siting Procedures

Complete planning and antenna siting procedures include coverage of the following subjects in the order listed.

- a.* Site considerations (para 6-6).
- b.* Performance prediction (para 6-7).
- c.* Antenna placement, assembly, and orientation (para 6-11).

6-6. Site Considerations

a. Distance Between Sites. A typical distance between sites is 100 miles. The accuracy of performance predictions for distances over 100 miles decreases with increased distances

b. Accessibility. The proposed site must be accessible from the air or road so that the equipment can be moved in and out with minimum difficulty. Accessibility of fuel, water, and food must be considered and coordinated with support organizations. Topographical maps and field surveys will aid in determining if the area is accessible.

c. Terrain.

- (1) Avoid locations near powerlines or electrical noise sources.
- (2) Antenna elevation angles (para 6-9f) depend on the height of obstructions that must be cleared by the antenna beam path and will be less than 2 degrees. The smaller the antenna elevation angle, the more preferable the condition.
- (3) Avoid a location that will result in vegetation in the beam path of the antenna.
- (4) Locate the antenna on hard packed or rocky ground. The ground must be suitable for accepting the emplacement of ground anchors.

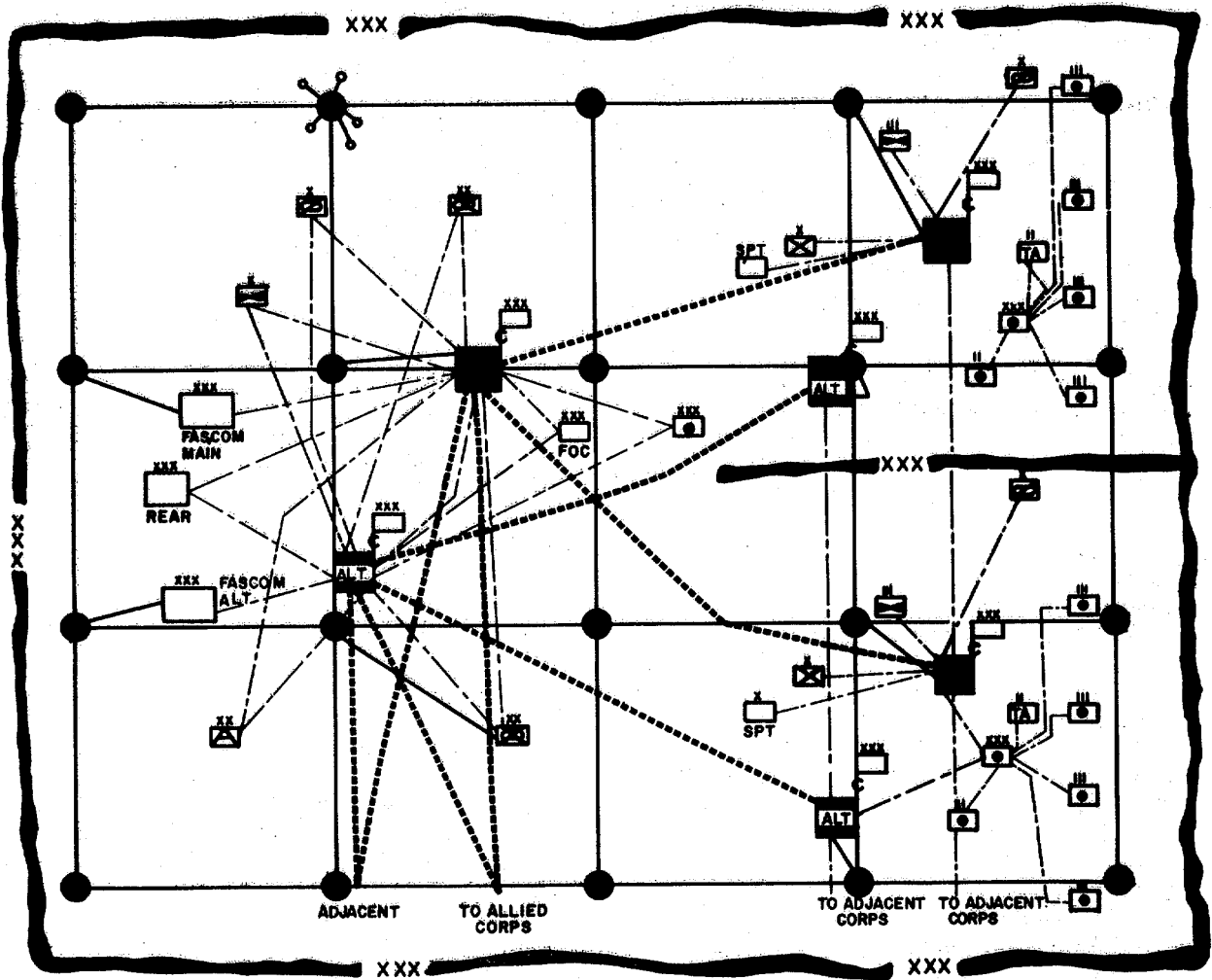

LEGEND:
 TROPO SCATTER SYSTEM
 _____ HIGH CAP SYSTEM
 - - - - - MEDIUM CAP SYSTEM

EL5895-459-14-TM-46

Figure 6-1. Typical employment of tropospheric scatter tactical radio relay system in tactical field Army.

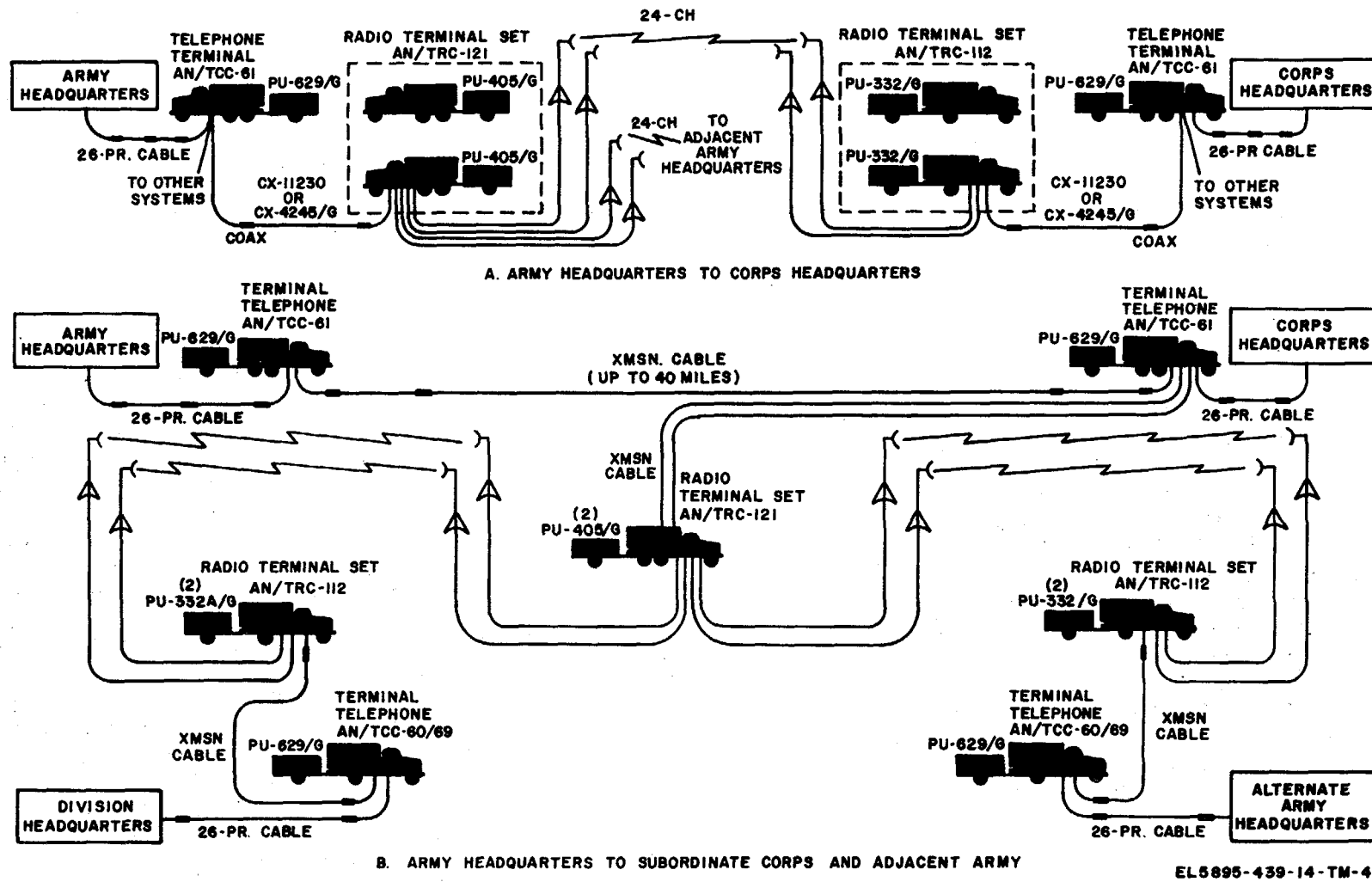

Figure 6-2. Typical applications of tropospheric scatter tactical radio relay system.

Table 6-1. System Assemblages

Assemblage nomenclature	Major component complement														Primary employment	
	T-961/GRC-143	R-1267/GRC-143	RT-834/GRC-106A	PP-4763A/GRC	TD-204/U	TD-332/U	CV-1348/G	CV-435/U	CN-514/ORC	AM-6990/GRC-143	AM-3349/GRC-106A	AN/TRA-37	LS-MKC/FI	TA-312/PT		TSEC-MG-77
Terminal Set, Telephone AN/TCC-60	0	0	0	0	2**	2	2	0	1	0	0	0	1	1	2*	Corps and Army Command System with radio, or Army Area with cable to major headquarters (fig. 6-2)
Terminal Set, Telephone AN/TCC-61	0	0	0	0	8**	8	8	0	1	0	0	0	1	1	8*	Corps and Army Command System with cable terminal and radio terminal applications (fig. 6-2)
Terminal Set, Telephone AN/TCC-69	0	0	0	0	2**	2	2	0	1	0	0	0	1	1	2*	Corps and Army Command System with radio, or Army Area with cable to major headquarters (fig. 6-2)
Radio Terminal Set AN/TRC-112	1	1	1	1	0	0	0	1	0	1	1	1	0	1	0	Corps and Army Command System with radio and cable to subordinate corps and adjacent army (fig. 6-2)
Radio Terminal Set AN/TRC-121	2	2	1	1	0	0	0	2	0	2	1	2	0	2	0	Corps and Army Command System with cable and radio facilities to subordinate corps and adjacent army (fig. 6-2)

*Optional

**Interchangeable with TD-754/G.

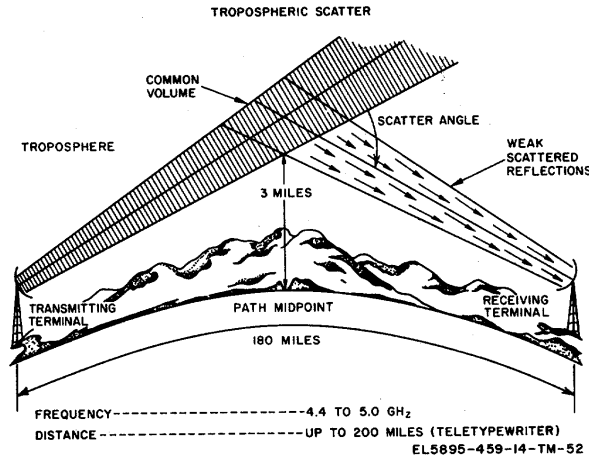

Figure 6-3. Propagation of tropospheric scatter radio signals.

6-7. Performance Prediction

Prior to movement and placement of the equipment, a performance prediction of the proposed siting should be made. To predict performance of a circuit between two sites, the systems planner must know what the expected received signal level will be. The signal level at the receiver input terminals is the difference between the effective transmitted power and the propagation losses. These factors are discussed in the following paragraph. A detailed procedure for determining circuit reliability and hence the feasibility of a proposed system is described in paragraph 6-9.

6-8. Propagation Losses

The following factors must be considered when calculating circuit reliability:

- a. *Basic Propagation Loss (BPL)*. This is the signal degradation inherent in tropospheric radio transmission.

The expression for BPL is:

$$\begin{aligned}
 \text{BPL} &= \text{free space loss \& scatter loss} \\
 &= 20 \log F + 20 \log D + 37 + \text{scatter loss} \\
 D &= \text{path length in miles} \\
 F &= \text{frequency in MHz.}
 \end{aligned}$$

In other words, BPL is directly related to the operating frequency, the distance between terminals and the scatter loss-the additional deterioration of signal strength incurred as the signal scatters from the common volume (fig. 6-3). The scatter loss can vary as follows:

- (1) The angle at which the antenna must be aimed to clear the horizon is called the horizon angle. If the surface of the earth is smooth, the antenna is aimed along the tangent to earth's surface, and the horizon angle is zero. This is the condition assumed when figuring basic propagation loss. When there is an obstruction in front of the antenna, such as a hill or mountain, the antenna must be aimed at a higher angle to clear the horizon. This increases the scatter angle and raises the height of the scatter volume, as shown in figure 6-4. An increase in either of these circuit features increases the scatter loss for the circuit. This increase in loss must be added to the basic propagation loss.

- (2) If the antenna is located on a site higher than the terrain in the foreground, it can be aimed

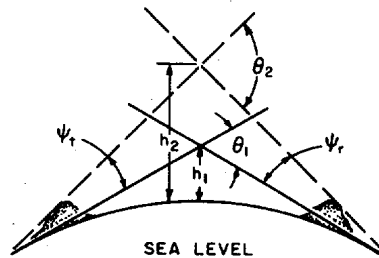

- ψ_t = HORIZON ANGLE AT TRANSMIT SITE
- ψ_r = HORIZON ANGLE AT RECEIVE SITE
- θ_1 = SCATTER ANGLE WITH SMOOTH EARTH
- θ_2 = SCATTER ANGLE WITH RAISED HORIZON
- h_1 = HEIGHT OF SCATTER VOLUME WITH SMOOTH EARTH
- h_2 = HEIGHT OF SCATTER VOLUME WITH RAISED HORIZON

EL 5895-459-14-TM-53

Figure 6-4. Effect of obstacles on horizon angle.

down from a zero horizon angle. This negative horizon effect is shown in figure 6-5. When the horizon angle is negative, the scatter angle and the height of the scatter volume are decreased. This results in a circuit loss that is less than the basic propagation loss.

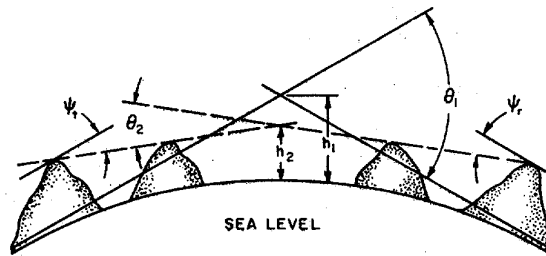

- ψ_t = HORIZON ANGLE AT TRANSMIT SITE
- ψ_r = HORIZON ANGLE AT RECEIVE SITE
- θ_1 = SCATTER ANGLE WITH SMOOTH EARTH
- θ_2 = SCATTER ANGLE WITH RAISED HORIZON
- h_1 = HEIGHT OF SCATTER VOLUME WITH SMOOTH EARTH
- h_2 = HEIGHT OF SCATTER VOLUME WITH RAISED HORIZON

EL 5895-459-14-TM-54

NOTE: NEGATIVE ELEVATION ANGLES RELATIVE TO SITE EARTH TANGENT.

EL 5895-459-14-TM-54

Figure 6-5. Negative horizon angles.

(3) If the antenna at one site is aimed at a certain angle to clear the horizon, the scatter angle and height of the scatter volume are increased a corresponding amount from zero angle conditions. An increase in horizon angle at the other site will also cause a corresponding increase in scatter angle and height. The total effect of horizon angles on circuit loss depends on the sum of the horizon angles. The effect of horizon angles decreases with circuit length because the fractional increase in scatter angle for a given change in horizon angle is much greater at the shorter distances.

b. *Fading.* Variations in signal strength occur constantly due to rapid changes in the scatter volume. Signal strength also varies seasonally because of changes in the general conditions of the troposphere.

c. *Aperture-to-Medium Coupling Loss.* To offset the large losses discussed above, large high-gain parabolic antennas are employed. However, as the size of the antennas increases, a phenomena, known as aperture-to-medium coupling loss, occurs. This loss is due to the reduction of scatter volume as shown in figure 6-6.

6-9. Tropospheric Scatter Systems Engineering

The following procedures will aid in the calculation of system reliability. In most cases the mathematical values of the applicable formulas have been plotted on graphs and nomograms. The end result is merely an estimate and should not be construed as an absolute figure. Complete table 6-2 according to the procedures in a through o as follows.

a. *Circuit Path Length.* Record the distance (in miles) between the proposed terminals in the space provided in item 1.

b. *Operating Frequency.* In item 2 of table 6-2, enter the proposed frequency (in GHz) to be used.

c. *Sum of Horizon Angles.* The horizon angle can be determined by using a transit at each site and sighting along the circuit path. Another method, which eliminates the need of visiting the proposed site is described below:

(1) Consulting a topographical map of the proposed circuit prepare a path profile chart showing the location and elevation of each antenna and all high and low points between the two sites.

(2) Draw a line from the center of site A's

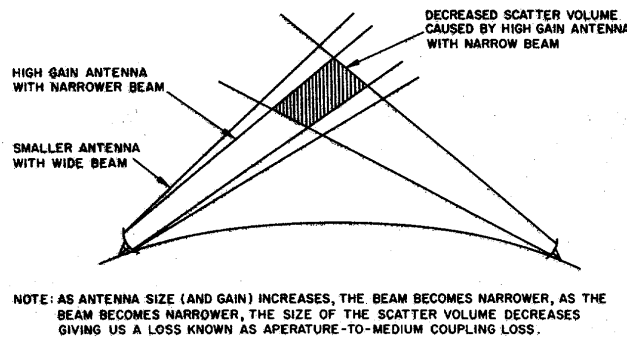

Figure 6-6. Aperture-to-medium coupling loss.

Table 6-2. Table of Tropospheric Scatter Path Calculations

PATH CHARACTERISTICS

- 1. Circuit Path Length..... _____ Miles
- 2. Operating Frequency..... _____ GHz
- 3. Sum of Horizon Angles..... _____ degrees

EFFECTIVE TRANSMITTER POWER

- 4. Transmitter Power 60 dBm
- 5. Antenna Gain (Gain over Isotropic Antenna) _____ dB
- 6. Antenna Beamwidth _____ degrees
- 7. Transmission Line Loss 1.0 dB
- 8. Total Effective Transmitted Power _____ dBm

PROPAGATION LOSS

- 9. Basic Propagation Loss..... _____ dB
- 10. Horizon Angle Loss _____ dB
- 11. Aperture-to-Medium Coupling-Loss _____ dB
- 12. Total Propagation Loss..... _____ dB
- 13. Predicted Median Signal Level..... _____ dBm

SIGNAL LEVEL REQUIRED FOR THRESHOLD

- 14. Required Signal Level For Threshold. _____ dBm

NOTE

For 12 channel, single Rec. insert -100 in 14 above.
 For 12 channel, combiner operation w/equal signals, insert -103 in 14 above.
 For 24 channel, single Rec. insert -97 in 14 above.
 For 24 channel, combiner operation w/equal signals, insert -100 in 14 above.

FADE MARGIN

- 15. Difference Between Level Required for Threshold and Predicted Median Level..... _____ dB

CIRCUIT RELIABILITY

- 16. Percentage of Time Reception can be Expected..... _____ %

antenna tangent to the highest obstacle over which the beam must pass without intersecting any other obstacle depicted on the path profile chart

(3) Determine the distance from site A to the tangent point described in (2) above.

(4) Find the difference between the elevation at the tangent point and the elevation of the antenna. (Always subtract antenna height from terrain height, observing whether the result is a positive or negative number.) Depending on the distance computed in (3) above, use either A or B of figure 6-7; use A when the distance is less than 14.5 miles; use B when the distance is greater than 14.5 miles. Find the corresponding horizon angle.

(5) Repeat steps (2) through (4) for site B. Add the two horizon angles together and record the sum in the space provided in item 3.

d. *Transmitter Power.* The nominal power output for the T-96 1/GRC- 143 is 1,000 watts. This value has been converted to 60 dBm and entered in item 4.

e. *Antenna Gain and Beamwidth.* Referring to figure 6-8, find the directive gain of the antenna (expressed in dBs) corresponding to the reflector diameter (10 feet) and the operating frequency (item 2) and record this value in item 5. Find the

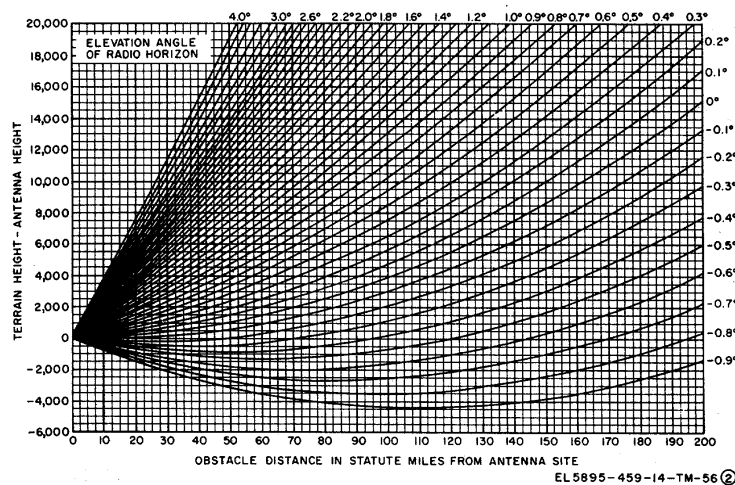
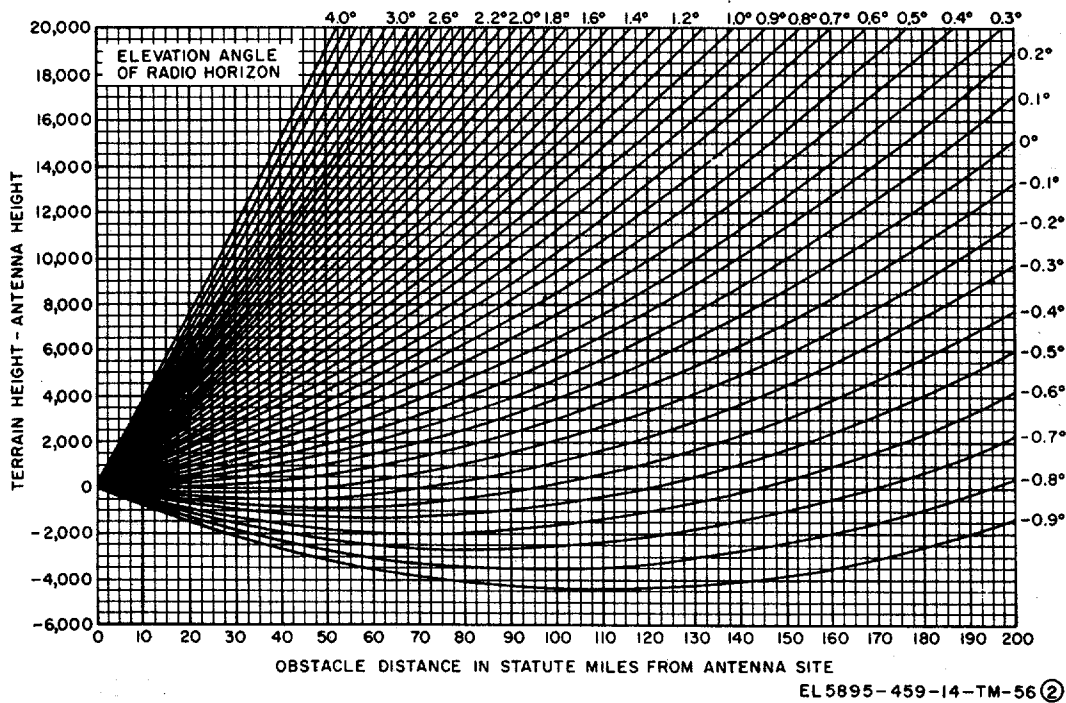

Figure 6-7Ⓛ. Horizon angle determination curves (part 1 of 2)
 Change 1 6-7



beamwidth directly opposite the gain and record this value in item 6.

f. *Transmission Line Loss.* The attenuation of the signal by the transmission line (WR-187 flexible waveguide) is 1 dB /25 feet. This value has already been recorded in item 7.

g. *Total Effective Transmitter Power.* The effective power is equal to the transmitter power (item 4) plus the antenna gain (item 5) minus the transmission line losses (item 7). Record this total in the space provided in item 8.

h. *Basic Propagation Loss.* First calculate the loss at 1,000 MHz. Apply the circuit length (item 1) to either the large graph or the inset shown in figure 6-9. Read the loss along the left margin. To correct for the difference between the operating frequency (item 2) and 1,000 MHz, use the graph shown in figure 6-10. Add these two losses and put the sum in the blank provided in item 9.

i. *Horizon Angle Loss.* Apply the sum of the horizon angles (item 3) to the graph in figure 6-11 and use the plotted line corresponding to the proposed circuit path length (item 1) to determine horizon angle loss. If this value is negative, consider it as a gain. Record the result in item 10.

j. *Aperture-to-Medium Coupling Loss.* Referring to figure 6-12, find the scatter angle (for a smooth earth surface) corresponding to the proposed circuit path length (item 1). To this value add the sum of the horizon angles (item 3). Using a straight edge, draw a line from the sum of these angles to the position on the righthand scale representing the antenna beamwidth (item 6). Find the point at which this line intersects the center scale and record that value in the space provided in item 11.

k. *Total Propagation Loss.* Add the losses incurred in items 9 through 11 and record the sum in item 12. Remember that a negative horizon angle will give an effective gain. Such a gain should be subtracted from the losses.

l. *Predicted Median Signal Level.* Subtract the total propagation loss (item 12) from the total effective transmitted power (item 8) giving the predicted strength of the signal at the input to the distant receiver. This figure will have a negative value in dBm, thus representing a small fraction of a milliwatt. Record this value in item 13.

m. *Required Signal Level for Threshold.* The minimum signal strength which can be detected by the R-1287/GRC-143, allowing for internally generated noise is -224.5 dBm. This figure has already been entered in item 14.

n. *Fade Margin.* The fade margin is the difference (in dBs) between the predicted median signal level (item 13) and the signal strength required for threshold (item 14). This figure, to be entered in item 15, represents the safety margin that allows reception of the signal if it should dip below the predicted level.

c. *Circuit Reliability* This value represents the percentage of time that signal reception can be expected. To calculate circuit reliability, apply the fade margin (item 15) to the graph in figure

6-13. Record the result in item 16 and compare it to the reliability standards cited in 6-9p.

p. *Standards of Reliability.* The required reliability for a tropospheric scatter system depends on the type of service desired. These are:

- (1) Multichannel voice only: 98.00 %
- (2) Teletypewriter: 99.90 %
- (3) Data: 99.99 %

If the proposed circuit meets these reliability standards, install and align the system as described in paragraphs 6-10 and 6-11. If the circuit fails to achieve the above standards, the systems planner should consider the relocation of the proposed sites.

6-10. System Installation, Assembly, and Line-Up

After the performance prediction has been calculated and approved, system components may be installed. Consult the appropriate technical manuals for installation, assembly, and line-up procedures. Refer to the site considerations described in para 6-6.

6-11. Antenna Assembly and Orientation

The antenna must be situated and assembled according to the procedures covered in TM 11-5985-324-15 and in conformance with the site considerations described above. Prior to orientation, it is required that all antenna associated equipment be installed and ready for operation.

a. *Coarse Orientation.* Using the procedures in TM 11-5985-324-15, each antenna must be adjusted to the elevation angles calculated in 6-9c. Each antenna must be oriented to the proper Figure 6-9. Free space attenuation at 1,000 MHz.

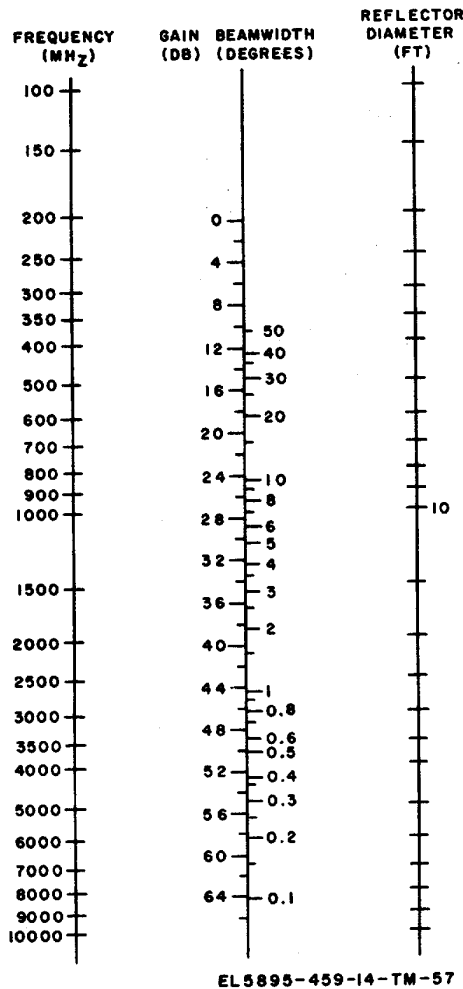

EL 5895-459-14-TM-57

Figure 6-8. Antenna gain and beamwidth.

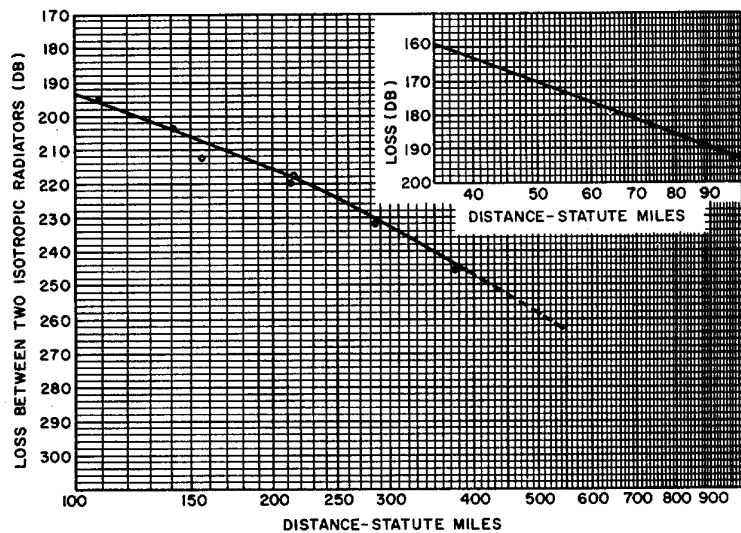

EL 5895-459-14-TM-58

Figure 6-9. Free space attenuation at 1,000 MHz.

bearing as determined through the use of topographical maps. Make certain that the topographical map declination diagram as concerns due north, grid north, and magnetic north is taken into account when the antennas are adjusted for azimuth setting.

b. *Fine Orientation.* After coarse antenna adjustments have been made, order-wire communications may be established between sites. Refer to procedures described in TM 11-6820-595-12 and adjust antenna orientation for maximum indications on the antenna alignment meters.

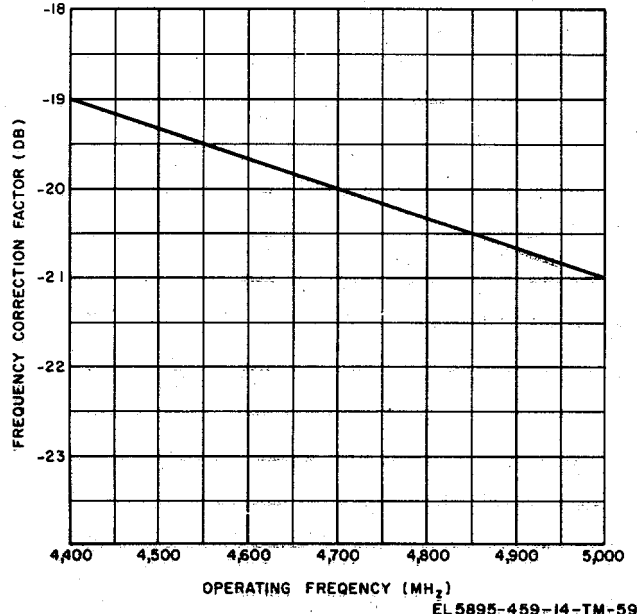

EL 5895-459-14-TM-59

Figure 6-10. Correction table for free space attenuation at frequencies between 4.4 and 5.0 GHz.

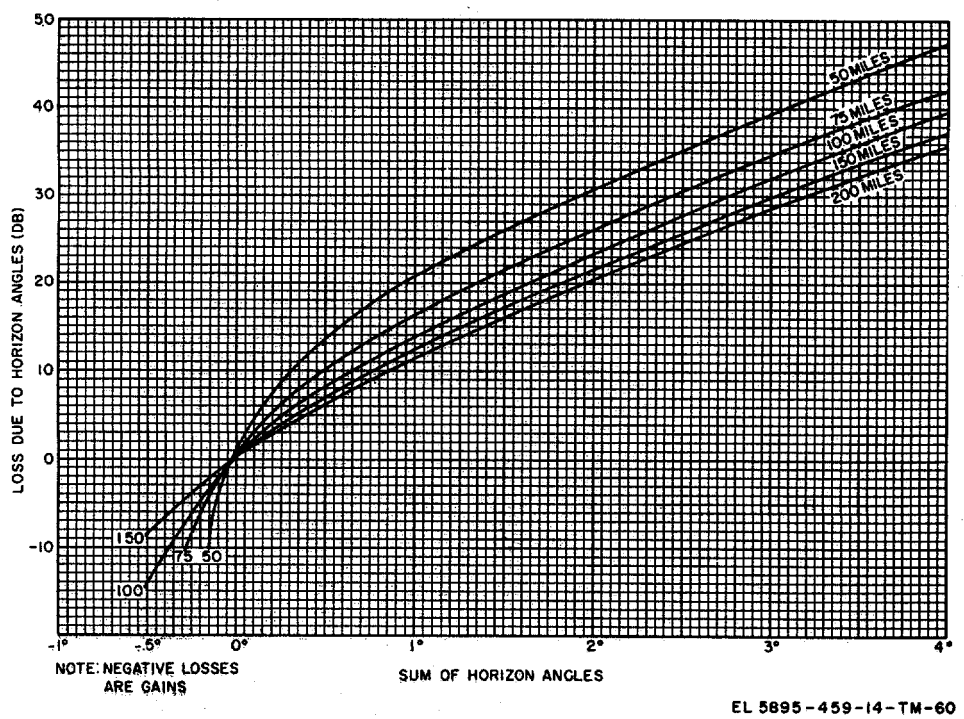

EL 5895-459-14-TM-60

Figure 6-11. Horizon angle loss.
6-10

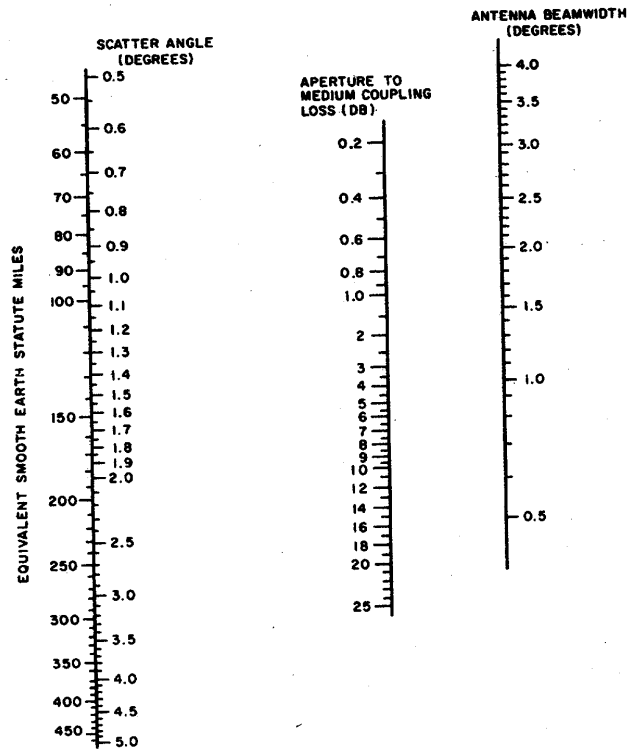

EL 5895-459-14-TM-61

Figure 6-12. Calculation of aperture-to-medium coupling loss.

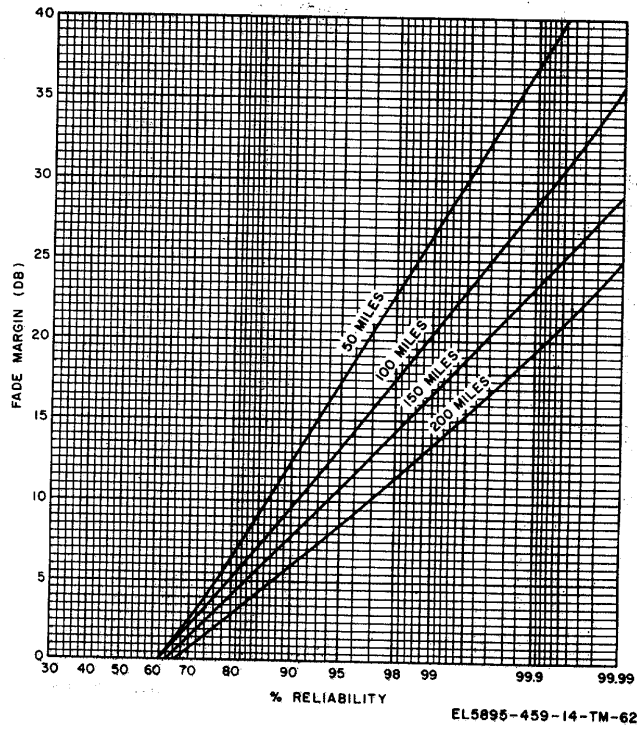

Figure 6-13. Circuit reliability.

CHAPTER 7

MAINTENANCE CONCEPT

7-1. General

a. The maintenance concept for the Tropospheric Scatter Tactical Radio Relay System provides maximum utilization of the system with minimum downtime. An assemblage technical manual is provided with each assemblage to provide complete installation and operation. Troubleshooting and repair procedures are provided in the assemblage technical manual in accordance with the maintenance allocation chart. Defective items are forwarded to higher category maintenance where component technical manuals are available. The component technical manuals provide troubleshooting and repair procedures for direct support, general support, and depot maintenance personnel. No maintenance float is provided for the shelter facilities or the assemblages, but maintenance float items are stocked at direct support as required to support the authorized organizational quantities of assemblages.

b. Each assemblage technical manual contains a basic issue items appendix which lists the items supplied for initial operation and for running spares. The list includes special tools, parts, and material issued as part of the major end item. The list includes all items authorized for basic operator maintenance of the equipment. End items of equipment are issued on the basis of allowance prescribed in equipment authorization tables and other documents that are a basis for, requisitioning parts.

c. Each assemblage technical manual also contains a maintenance allocation appendix that defines the type of maintenance authorized to be performed by the various maintenance categories. It authorizes specific maintenance functions on repairable items and components and the tools and test equipment required to perform each function. This appendix can be used as an aid in planning maintenance operations. A brief description of the authorized maintenance functions for each category of maintenance is provided in paragraphs 7-2 through 7-5.

d. Each assemblage is supplied with a copy of TB SIG 354 which covers the authorized maintenance and repair procedures for the shelters.

7-2. Organizational Maintenance

a. *Operator.* An assemblage operator is authorized to perform preventive maintenance as indicated in (1) below and troubleshooting and repair as indicated in (2) below.

(1) *Preventive maintenance.* Daily preventive maintenance is performed to insure that each assemblage will have a minimum downtime. The daily preventive maintenance procedures are outlined in the assemblage technical manual and consist of the following:

- (a) Complete check for normal operation.
- (b) Making operational adjustments and alignments that do not require the use of test equipment and tools.
- (c) External cleaning of the components.
- (d) Visual inspection for damage, deterioration and potential trouble areas.

(2) *Troubleshooting and repair.*

(a) Built-in test facilities in the pcm components, and operational tests of the radio, voltage regulator, telephone, intercom, and security components are used to isolate troubles to defective plug-in panels and subassemblies and parts in the components. The operator is authorized to replace parts that are designated as running spares in the basic items appendix of the assemblage technical manual.

(b) The assemblage operator is authorized to replace lamps, starters, and cable assemblies in the shelter facility.

b. *Organizational Maintenance.* The organizational maintenance personnel are authorized to perform preventive maintenance as indicated in (1) below and troubleshooting and repair as indicated in (2) below.

(1) *Preventive maintenance.* Monthly and quarterly preventive maintenance is performed to insure that each assemblage will have a minimum downtime. The monthly and quarterly preventive maintenance procedures are outlined in the assemblage technical manual and consist of the following:

- (a) Making operational adjustments and alignment beyond the scope of the operator.
- (b) Internal cleaning of the components.
- (c) Complete inventory and requisitioning of all authorized items.

(2) *Troubleshooting and repair.*

(a) Authorized tools and test equipment are used to isolate troubles to defective plug-in panels (that cannot be isolated with the built-in test facilities in the components). Organizational maintenance personnel are authorized to replace

all plug-in panels or plug-in parts in a pcm component, tubes or tuning head in a radio component, tubes in the voltage regulator or intercom components, a complete component, and replace any defective signal or power cable.

(b) Organizational maintenance personnel are authorized to repair skin punctures (with Fiberglass patches) of the shelter facility to render the facility weathertight, and intake repairs. on the alternating-current (ac) power distribution system. Replacement of parts not in the power distribution system is limited to easily removed parts such as gaskets, door filter, etc.

7-3. Direct Support Maintenance

a. Direct support maintenance personnel use authorized tools and test equipment to make adjustments and alignments beyond the scope of organizational personnel.

b. Direct support maintenance personnel are authorized to isolate troubles to and replace chassis and panel-mounted such as switches, fuseholders, etc., in the pcm components, but are not authorized to isolate defective parts on printed-wiring board plug-in panels. Direct support maintenance personnel are authorized to isolate troubles to and replace subassemblies or chassis mounted parts of the radio components.

NOTE

Direct support maintenance personnel are not authorized to replace 31 -pin connectors or parts mounted on printed. wiring board plug-in panels of the pcm components or parts in the subassemblies of the radio components.

c. Direct support maintenance personnel are authorized to repair all skin punctures of the shelter facility (including repair of unsound Fiberglass patches). Replacement of all parts secured with removable fasteners, such as steps, hinges, etc., is authorized.

7-4. General Support Maintenance

a. General support maintenance personnel use authorized tools and test equipment to make adjustments and alignments beyond the scope of direct support maintenance personnel.

b. General support maintenance personnel are authorized to isolate trouble to defective parts (resistors, capacitors, etc.), except those which are part of throwaway type modules that are replaced as units.

c. General support maintenance personnel are authorized to replace all defective parts or throwaway type of modules and test the components to be sure that they meet the minimum user requirements for return to the using organization.

d. General support maintenance personnel are authorized to complete repair of shelter facilities within their maintenance capability, providing the repairs are sufficiently sound and will not impair safe operating practices by using organizations.

7-5. Depot Maintenance

a. Depot maintenance personnel are authorized to overhaul or rebuild severely damaged equipment which requires shop facilities more elaborate than general support maintenance facilities.

b. Depot maintenance personnel test overhauled or rebuilt equipment to insure that it functions in accordance with the Depot Maintenance Work Requirements.

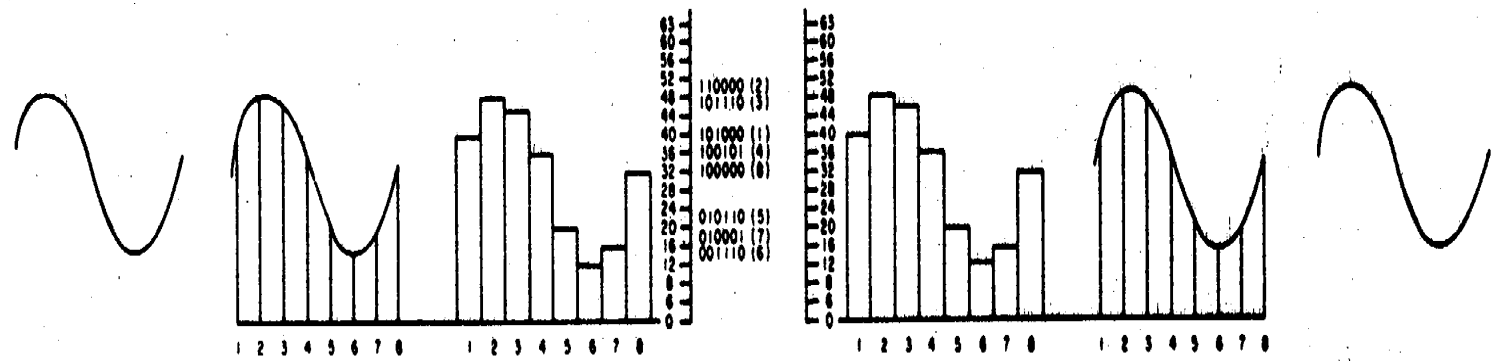
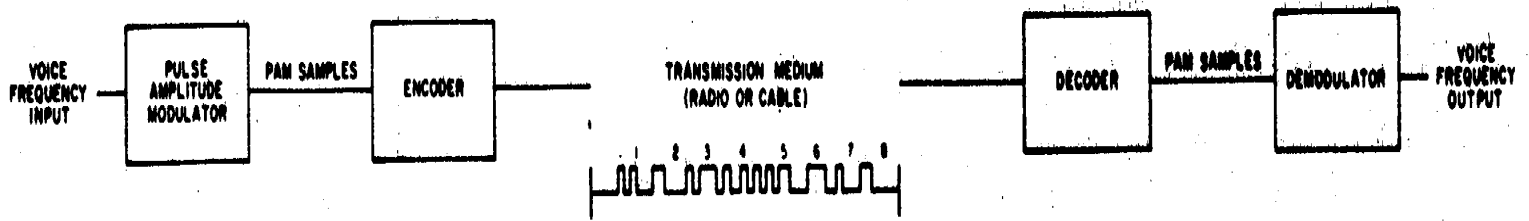

EL5895-459-14-TM-48

Figure 7-1. Voice transmission by pulse code modulation.

APPENDIX

REFERENCES

DA Pam 310-4	Index of Technical Manuals, Technical Bulletins, Supply Manuals (types 7, 8, and 9), Supply Bulletins, and Lubrication Orders
DA Pam 310-7	Modification Work Orders
TB 750-240	Maintenance and Repair Procedures for S-141/G, S-144/G, S-250/G, S-280/G, and S-318/G Type Shelters
TM 11-5410-214-15P	Operator's, Organizational, Direct Support, General Support, and Depot Maintenance Repair Parts and Special Tools Lists: Shelter, Electrical Equipment S-250/G
TM 11-5410-212-15P	Organizational, DS, GS, and Depot Maintenance Repair Parts and Special Tool Lists: Shelter, Electrical Equipment S-318/G
TM 11-5410-213-14P	Operator's, Organizational, Direct Support and General Support Maintenance Repair Parts and Special Tools Lists (Including Depot Maintenance Repair Parts and Special Tools): Shelters Electrical Equipment S-280A/G (NSN 5410-00-999-6022) and S-280B/G (NSN 5410-00-117-2868)
TM 11-5805-201-12	Operator's and Organizational Maintenance Manual Including Repair Parts and Special Tools Lists: Telephone Set TA-312/PT (TO 31W1-2PT-291)
TM 11-5805-201-35	Direct Support, General Support and Depot Maintenance Manual Including Repair Parts and Special Tools Lists: Telephone Set TA-312/PT (TO 31W1-2PT-292)
TM 11-5805-356-12	Operator, and Organizational Maintenance Manual Including Repair Parts and Special Tools List: Terminal, Telegraph-telephone AN/TCC-29 (including Terminal, Telegraph TH-22/TG and Converter Telegraph-telephone Signal CV-425/U)
TM 11-5805-356-35	Direct Support, General Support, and Depot Maintenance Manual (Including Repair Parts and Special Tools List): Terminal Telegraph-telephone AN/TCC-29 (including Terminal, Telegraph TH-22/TC and Converter Telegraph-telephone Signal CV-425/U)
TM 11-5805-357-15	Operator's, Organizational, Direct Support, General Support, and Depot Maintenance Manual Including Repair Parts and Special Tools Lists: Terminal Set Telephone AN/TCC-61
TM 11-5805-358-15	Operator's, Organizational, Direct Support, General Support, and Depot Maintenance Manual Including Repair Parts and Special Tools Lists: Terminal Sets, Telephone AN/TCC-60 and AN/TCC-69.
TM 11-5805-367-12	Operator's and Organizational Maintenance Manual: Multiplexers TD-202/U, TD-203/U, TD-204/U, TD-362/U, and TD-353/U, Restorer, Pulse Form TD-206/G, and Converter, Telephone Signal CV-1548/G and CV-1548A/G
TM 11-5805-367-25P/1-1	Organizational, Direct Support, General Support and Depot Maintenance Repair Parts and Special Tools Lists: Multiplexer TD-202/U.
TM 11-5805-367-25P/1-2	Organizational, Direct Support, General Support and Depot Maintenance Repair Parts and -Special Tools Lists: Multiplexer TD-203/U.
TM 11-5805-367-25P/2	Organizational, Direct Support, General Support, and Depot Maintenance Repair Parts and Special Tools Lists: Multiplexer TD-204/U.
TM 11-5805-367-25P/3-1	Organizational, Direct Support, General Support, and Depot Maintenance

	nance Repair Parts and Special Tools Lists: Multiplexer TD-352/U.
TM 11-5805-367-25P/3-2	Organizational, Direct Support, General Support, and Depot Maintenance Repair Parts and Special Tools Lists: Multiplexer TD-353/U.
TM 11-5805-367-24P/4	Organizational, DS, GS, Maintenance Repair Parts and Special Tool Lists: Restorer, Pulse Form TD-206/G.
TM 11-5805-367-25P/5	Organizational, DS, GS, and Depot Maintenance Repair Parts and Special Tool Lists: Converter, Telephone Signal CV-1548/G.
TM 11-5805-367-35/1	Direct Support, General Support, and Depot Maintenance Manual: Multiplexers TD-202/U and TD-203/U.
TM 11-5805-367-36/9	Direct Support, General Support, and Depot Maintenance Manual: Multiplexer TD-204/U.
TM -5805-367-35/3	Direct Support, General Support, and Depot Maintenance Manual: Multiplexers TD-352/U and 353/U.
TM 11-5805-367-36/4	Direct Support, General Support, and Depot Maintenance Manual: Restorer, Pulse Form TD-206/G.
TM 11-5805-367-34-5	Direct Support and General Support Maintenance Manual: Converters, Telephone Signal CV-1548/G and CV-1548A/G.
TM 11-5805-383-12	Operator's and Organizational Maintenance Manual: Including Repair Parts and Special Tools List: Multiplexer TD-754/G.
TM 11-5805-883-35	Direct Support, General Support, and Depot Maintenance Manual Including Repair Parts and Special Tool Lists: Multiplexer TD-754/G.
TM 11-5820-520-12	Operator's and Organizational Maintenance Manual, Including Repair Parts and Special Tools Lists: Radio Sets AN/GRC-106 and At4/GRC-106A.
TM 11-5820-520-26P	Organizational, DS, GS, and Depot Maintenance Repair Parts and Special Tools List: Radio Set AN/GRC-106.
TM 11-5820-520-34	Direct Support and General Support Maintenance Manual: Radio Set AN/GRC-106(NSN 5820-00-167-8003) and Radio Set AN/GRC-106A(NSN 5820-00-147-8005).
TM 11-5820-556-16	Operator's, Organizational, Direct Support, General Support, and Depot Maintenance Manual, Including Repair Parts and Special Tools Lists: Radio Terminal Set AN/TRC-112.
TM 11-5820-595-12	Operator and Organizational Maintenance Manual Including Repair Parts, and Special Tools Lists: Radio Set AN/GRC-143.
TM 11-5820-596-35	DS, GS, and Dep6t Maintenance Manual: Radio Set AN/GRC-148
TM 11-5820-602-15	Operator's, Organizational, Direct Support and General Support Maintenance Manual Including Repair Parts and Special Tools Lists: Radio Terminal Set AN/TRC-121.
TM 11-5820-765-12	Operator's and Organizational Maintenance Manual: Power Supplies PP-476\$/GRC and PP-4763A/GRC.
TM 11-5820-765-35	Direct Support, General Support, and Depot Maintenance Manual Including Repair Parts and Special Tools Lists: Power Supply PP-4763/GRC and Power Supply PP-4763A/GRC.
TM 11-5830-221-12	Operator's and Organizational Maintenance Manual: Intercommunication Stations LS-147A/FI, LS-147B/FI, LS-147C/FI, and LS-147D/FI
TM 11-5830-221-24P	Organizational, Direct Support, and General Support Maintenance Repair Parts and Special Tools Lists, Including Depot Maintenance Repair Parts and Special Tools: Intercommunication Station LS-147C/FI (FSN 5830-752-5357)
TM 11-5830-221-35	Field and Depot Maintenance Manual: Intercommunication Stations LS-147A/FI, LS-147B/FI, LS-147C/FI, and LS-147D/Fi
TM 11-5985-324-15	Operator, Organizational, DS, GS, and Depot Maintenance Manual

TM 11-6110-245-15	Including Repair Parts and Special Tools List: Antenna Group AN/TRA-37 and Transit Frames, Antenna MT-3894/TRC and MT-3895/TRC
TM 11-6625-648-12	Operator, Organizational, DS, GS, and Depot Maintenance Manual: Voltage Regulator CN-514/GRC
TM 38-450	Operator and Organizational Maintenance Manual: Test Set, Telephone AN/PTM-7 The Army Maintenance Management System (TAMMS)

GLOSSARY

- Assemblage - Complete end item equipment including shelter facility, all operating components, and interconnecting cables.
- Shelter - Shelter, Electrical Equipment S-250/G, S-280/G, or S-318/G.
- Shelter facility - A shelter, modified to contain (but not include) components and interconnecting cables. The shelter facility contains a completely installed ac power distribution system, equipment racks secured to the floor and walls, ;and signal wiring, but does not include the communications equipment.

Glossary 1

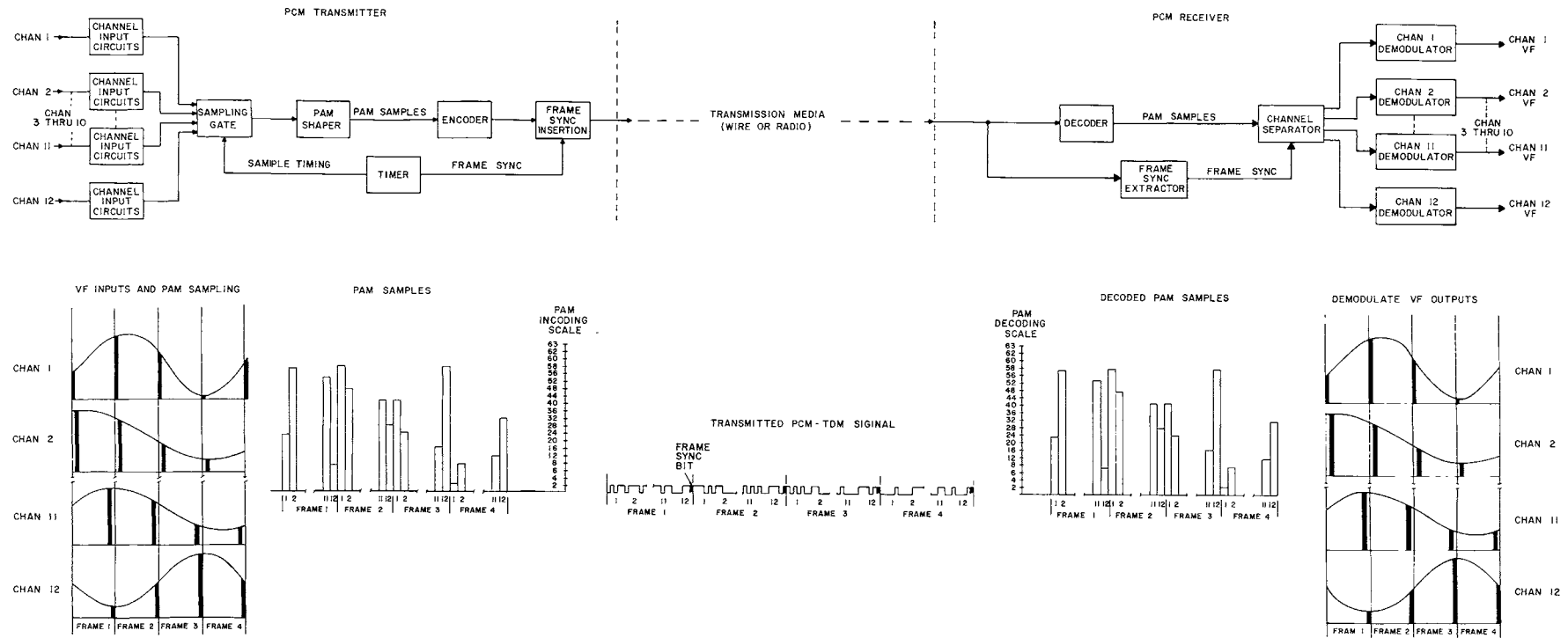

Figure FO-1. Pcm-tdm principle in TD-352/U.

TM 11-5895-459-14

By Order of the Secretary of the Army:

FRED C. WEYAND
General, United States Army
Chief of Staff

Official:

PAUL T. SMITH
Major General, United States Army
The Adjutant General

DISTRIBUTION:

Active Army:

USASA (2)	Fort Huachuca (10)
Dir of Trans (1)	WSMR (1)
COE (1)	Fort Carson (5)
TSG (1)	Ft Richardson (ECOM Ofc) (2)
USAARENBD (1)	Army Dep (1) except
AMC (1)	LBAD (14)
TRADOC (2)	SAAD (30)
ARADCOM (2)	TOAD (14)
ARADCOM Rgn (2)	SHAD (3)
OS Maj Comd (4)	Ft Gillem (10)
LOGCOMDS (3)	USA Dep (2)
MICOM (2)	Sig Sec USA Dep (2)
TECOM (2)	Sig Dep (2)
USACC (4)	SigFLDMS (1)
MDW (1)	USAERDAA (1)
Armies (2)	USAERDAW (1)
Corps (2)	MAAG (1)
HISA (Ft Monmouth) (43)	USARMIS (1)
Svc Colleges(1)	Units org under fol TOE:
USASESS (10)	(1 copy each unit)
USAADS (2)	11-35
USAFAS (2)	11-205
USAARMS (2)	11-215
USAIS (2)	11-237
USAES (2)	29-15
USAINTCS (3)	29-55
WRAMC (1)	29-85
ATS (1)	29-134
Fort Gordon (10)	44-235
	44-535

NG: None

USAR: None

For explanation of abbreviations used see AR 310-50.

* U.S. GOVERNMENT PRINTING OFFICE 1990 262-912 (30389)

RECOMMENDED CHANGES TO EQUIPMENT TECHNICAL PUBLICATIONS



THEN...JOT DOWN THE
DOPE ABOUT IT ON THIS FORM.
CAREFULLY TEAR IT OUT, FOLD IT
AND DROP IT IN THE MAIL.

SOMETHING WRONG WITH PUBLICATION

FROM: (PRINT YOUR UNIT'S COMPLETE ADDRESS)

DATE SENT

PUBLICATION NUMBER

PUBLICATION DATE

PUBLICATION TITLE

BE EXACT PIN-POINT WHERE IT IS

PAGE
NO.

PARA-
GRAPH

FIGURE
NO.

TABLE
NO.

IN THIS SPACE, TELL WHAT IS WRONG
AND WHAT SHOULD BE DONE ABOUT IT.

TEAR ALONG PERFORATED LINE

PRINTED NAME, GRADE OR TITLE AND TELEPHONE NUMBER

SIGN HERE

DA FORM 1 JUL 79 **2028-2**

PREVIOUS EDITIONS
ARE OBSOLETE.

P.S.--IF YOUR OUTFIT WANTS TO KNOW ABOUT YOUR
RECOMMENDATION MAKE A CARBON COPY OF THIS
AND GIVE IT TO YOUR HEADQUARTERS.

DEPARTMENT OF THE ARMY
US ARMY AG PUBLICATIONS CENTER
1655 W06DSON ROAD
ST. LOUIS, MISSOURI 63114

OFFICIAL BUSINESS